

# 3PHASE TRACK SYSTEM

Our 3Phase spotlights are also compatible to the 3Phase systems of other leading manufactures.

Spotlights for  
low-voltage bulbs  
MR16



Spotlights for  
low-voltage bulbs  
QRB111



Spotlights for  
high-voltage bulbs  
GU10



Spotlights for  
high-voltage bulbs  
ES111



Spotlights for  
high-voltage bulbs  
R7s



Spotlights for  
high-voltage bulbs  
PAR



Spotlights for  
energy-saving  
bulbs



Professional spots  
for the commercial  
use.

EFFICIENT  
PROFLIGHT



LED spotlights



**DOMELED**

**LED**  
LEDTEC

**Bulb:**  
PowerLED (incl.)  
6x 3W

**Material:**  
Aluminium/plastic

**Dimensions:**  
W/H/D: 22/18,5/3,8 cm

**Accessory/Included parts:**  
3Ph-adapter (incl.)  
LED converter (incl.)

**Versions:**  
silver grey  
LED white, 920lm  
LED warm white, 670lm

**Art. No.:**  
153501  
153502

**3PH 102 LED**

**LED**  
LEDTEC

**Bulb:**  
Planar LED (incl.)  
10W

**Material:**  
Aluminium

**Dimensions:**  
W/H/D: 11,5/13/9 cm

**Accessory/Included parts:**  
3Ph-adapter (incl.)  
LED converter (incl.)

**Versions:**  
silver grey  
LED white, 610lm  
LED warm white, 550lm

**Art. No.:**  
153601  
153602



## EURO SPOT G12

230~

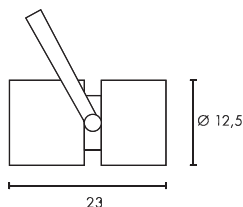
**PROF**EFFICIENT  
light.

**Socket/Bulb:**  
G12/HQLT; CDM-T (excl.)  
70W

**Material:**  
Aluminium

**Dimensions:**  
L/W: 32/16,5 cm  
Head-Ø/L: 12,5/23 cm

**Accessory/Included parts:**  
3Ph-adapter (incl.)  
Conventional ballast (incl.)
**Versions:**

silver grey

Angle of radiation 15°

Angle of radiation 60°

white

Angle of radiation 15°

Angle of radiation 60°

matt-black

Angle of radiation 15°

Angle of radiation 60°

**Art. No.:**

153404

153414

153401

153411

153400

153410

**Recommended bulb:**  
70W

507130, 3000K, 6600lm

507131, 4200K, 12700lm



## EURO SPOT SDW-TG

230~

**PROF**EFFICIENT  
light.

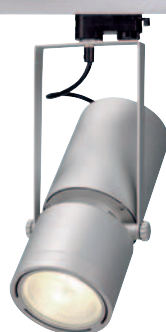
**Note:**  
Spot especially and only for use with  
the Philips SDW-TG Mini bulb.

**Socket/Bulb:**  
GX12-1/SDW-TG Mini (excl.)  
100W

**Material:**  
Aluminium

**Dimensions:**  
L/W: 37,5/15,6 cm  
Head-Ø/L: 12,5/30,5 cm

**Accessory/Included parts:**  
3Ph-adapter (incl.)  
Philips-electronic ballast (incl.)
**Versions:**

silver grey

Angle of radiation 38° ▼

white

Angle of radiation 38° ▼

**Recommended bulb:**  
100W, 2550K, 4900lm

508180



## EURO SPOT HIT-TC GU6,5

230~

**PROF**EFFICIENT  
light.

**Socket/Bulb:**  
GU6,5/HIT-TC (excl.)  
20W

**Material:**  
Aluminium

**Dimensions:**  
L/W: 26/11,5 cm  
Head-Ø/L: 8/25 cm

**Accessory/Included parts:**  
3Ph-adapter (incl.)  
Electronic ballast (incl.)
**Versions:**

silver grey

Angle of radiation 12° ▼

Angle of radiation 60° ▼

white

Angle of radiation 12° ▼

Angle of radiation 60° ▼

**Recommended bulb:**  
20W, 3000K, 1615lm

507020







THE PADDOCKS

THE PADDOCKS

**EURO SPOT QRB111**

**Socket/Bulb:**  
G53/QRB111 (excl.)  
75W max.

**Material:**  
Aluminium

**Dimensions:**  
L/W: 28/16,5 cm  
Head-Ø/L: 12,5/20 cm

**Accessory/Included parts:**  
3Ph-adpater (incl.)  
Conventional transformer (incl.)

**Versions:**  
matt-black  
white  
silver grey

**Art. No.:**  
153430  
153431  
153434

**Recommended bulb:**  
75W, 2700K  
24°, 3000cd 543724  
45°, 950cd 543745



**Recommended bulb:**  
PowerLED 10W, 40°, 430lm  
550132 warm white

**EURO SPOT ES111**

**Socket/Bulb:**  
GU10/ES111 (excl.)  
75W max.

**Material:**  
Aluminium

**Dimensions:**  
L/W: 24/16,5 cm  
Head-Ø/L: 12,5/14,5 cm

**Accessory/Included parts:**  
3Ph-adpater (incl.)

**Versions:**  
white  
silver grey

**Art. No.:**  
153421  
153424

**Recommended bulb:**  
75W, 24°, 2700K, 2000cd  
575672

**EURO SPOT E27**

**Socket/Bulb:**  
E27/EnergySaver (excl.)  
up to max. Ø/L: 6/17,5 cm

**Material:**  
Aluminium

**Dimensions:**  
L/W: 32/16,5 cm  
Head-Ø/L: 12,5/23 cm

**Accessory/Included parts:**  
3Ph-adpater (incl.)

**Versions:**  
white  
silver grey

**Art. No.:**  
153461  
153464

**Recommended bulb:**  
23W, 2700K, 1350lm, EEK=A  
508970





## EURO SPOT MR16

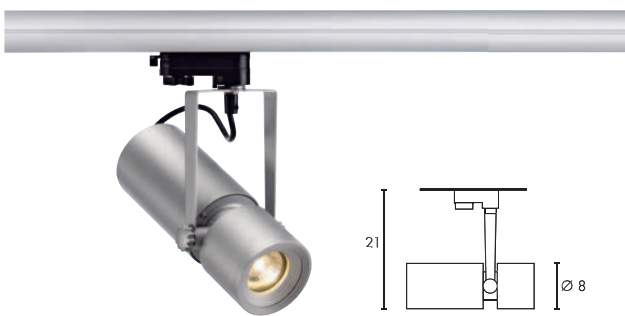

**Socket/Bulb:**  
GU5,3/MR16 (excl.)  
50W max.

**Material:**  
Aluminium

**Accessory/Included parts:**  
3Ph-adapter (incl.)  
Electronic transformer (incl.)

**Versions:**  
black  
white  
silver grey

**Art. No.:**  
153480  
153481  
153484

**Recommended bulb:**  
XENON  
50W, 40°, 2700K, 1400cd  
539540



## EUROSPOT LED DISK 800



**Bulb:**  
PowerLED module (incl.)  
14,5W, 800lm, 2700K

**Material:**  
Aluminium

**Dimensions:**  
Head Ø/L: 12,5/14 cm  
L/H: 14/22 cm

**Accessory/Included parts:**  
3Ph-adapter (incl.)  
LED converter (incl.)

**Versions:**  
LED warm white  
black  
white  
silver grey

**Art. No.:**  
153490  
153491  
153494





**SDL 70** Design by CDC

230~

**PROFi**EFFICIENT  
light.

 THE PROFESSIONAL  
**FN**  
LIGHT

**Socket/Bulb:**  
Rx7s/HQI-TS; CDM-TS (excl.)  
70W

**Material:**  
Aluminium

**Dimensions:**  
L/W/H: 39/25/10 cm

**Accessory/Included parts:**  
3Ph-adapter (incl.)  
Conventional ballast (incl.)

**Versions:**  
white  
silver grey

**Art. No.:**  
150551  
150552

**Recommended bulb:**  
70W, 4200K, 6500lm  
509071

**SDL 150** Design by CDC

230~

**PROFi**EFFICIENT  
light.

 THE PROFESSIONAL  
**FN**  
LIGHT

**Socket/Bulb:**  
Rx7s/HQI-TS; CDM-TS (excl.)  
150W

**Material:**  
Aluminium

**Dimensions:**  
L/W/H: 39/25/10 cm

**Accessory/Included parts:**  
3Ph-adapter (incl.)  
Conventional ballast (incl.)

**Versions:**  
white  
silver grey

**Art. No.:**  
150561  
150562

**Recommended bulb:**  
150W, 4200K, 12500lm  
509151

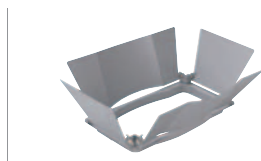
**ACCESSORY for SDL 70/150** Design by CDC

**Shutters**  
Aluminium  
white  
silver grey

**Art. No.:**  
150571  
150572

L/W/H: 38/27,5/3,5 cm

**SDL PRO 70** Design by CDC

230~

**PROFi**EFFICIENT  
light.

**Socket/Bulb:**  
Rx7s/HQI-TS; CDM-TS (excl.)  
70W

**Material:**  
Aluminium

**Dimensions:**  
L/W/H: 30/27/8 cm  
Bracket-H: 16 cm

**Accessory/Included parts:**  
3Ph-adapter (incl.)  
Electronic ballast (incl.)

**Versions:**  
white  
silver grey

**Art. No.:**  
153621  
153624

**Recommended bulb:**  
70W, 4200K, 6500lm  
509071

**SDL PRO 150** Design by CDC

230~

**PROFi**EFFICIENT  
light.

**Socket/Bulb:**  
Rx7s/HQI-TS; CDM-TS (excl.)  
150W

**Material:**  
Aluminium

**Dimensions:**  
L/W/H: 30/27/8 cm  
Bracket-H: 16 cm

**Accessory/Included parts:**  
3Ph-adapter (incl.)  
Electronic ballast (incl.)

**Versions:**  
white  
silver grey

**Art. No.:**  
153631  
153634

**Recommended bulb:**  
150W, 4200K, 12500lm  
509151





HQI-TS Flood 70 (150321) incl. 3Ph-adapter



HQI-TS Flood 70 (150302) without 3Ph-adapter,  
with plug, open cable end



HQI-TS Flood 70 (150312) incl. ceiling canopy

**HQI-TS FLOOD 70**

230~

**PROFiEFFICIENT**  
light.

**Socket/Bulb:**  
Rx7s/HQI-TS; CDM-TS (excl.)  
70W

**Material:**  
Steel

**Dimensions:**  
L/W/H: 20/20/10 cm

**Accessory/Included parts:**  
Conventional ballast (incl.)

**Versions:**  
3Ph-adapter (incl.)  
white  
silver grey

**Bracket, open cable end**  
white  
silver grey

**Art. No.:**  
150321  
150322

 150301  
150302

**Versions:**  
Ceiling canopy (incl.)  
white  
silver grey

**Recommended bulb:**  
70W, 4200K, 6500lm  
509071

**Art. No.:**  
150311  
150312

**HQI-TS FLOOD 150**

230~

**PROFiEFFICIENT**  
light.

**Socket/Bulb:**  
Rx7s/HQI-TS; CDM-TS (excl.)  
150W

**Material:**  
Steel

**Dimensions:**  
L/W/H: 24/24/10 cm

**Accessory/Included parts:**  
Conventional ballast (incl.)

**Versions:**  
3Ph-adapter (incl.)  
white  
silver grey

**Bracket, open cable end**  
white  
silver grey

**Art. No.:**  
150621  
150622

 150601  
150602

**Versions:**  
Ceiling canopy (incl.)  
white  
silver grey

**Recommended bulb:**  
150W, 4200K, 12500lm  
509151

**Art. No.:**  
150611  
150612

**Q-TECH® G12 HOR**

230~

**PROFiEFFICIENT**  
light.

**Socket/Bulb:**  
G12/HQI-T; CDM-T (excl.)  
70W

**Material:**  
Aluminium

**Dimensions:**  
Head-Ø: 12 cm  
W/H: 30,5/16 cm

**Accessory/Included parts:**  
3Ph-adapter (incl.)  
Electronic ballast (incl.)  
Reflector (excl.)

**Note:**  
Reflector see below.

**Versions:**  
white  
silver grey

**Recommended bulb:**  
70W  
507130, 3000K, 6600lm  
507131, 4200K, 12700lm

**Art. No.:**  
153201  
153204

**NAVIGATOR® G8,5**

230~

**PROFiEFFICIENT**  
light.

**Socket/Bulb:**  
G8,5/CDM-TC (excl.)  
70W

**Material:**  
Aluminium

**Dimensions:**  
L/W/H: 37,5/14/21,5 cm

**Accessory/Included parts:**  
3Ph-adapter (incl.)  
Electronic ballast (incl.)  
Reflector see below. (excl.)

**Versions:**  
silver grey

**Recommended bulb:**  
70W, 4200K, 6200lm  
507047

**Art. No.:**  
153164

**ACCESSORY for Q-Tech® G12 and Navigator® G8,5**

Reflector for Q-Tech® G12	24°	Art. No.:	153241
	44°		153244
	60°		153246
Aluminium			
Product-Ø: 10,5 cm			



Reflector for Navigator® G8,5	12°	Art. No.:	153171
	24°		153172
	44°		153174
Aluminium			
Product-Ø: 10,5 cm			
60°			153176



## SLEEK SPOT G12

230~

**PROF**  
**light.**

**Socket/Bulb:**  
 G12/HQI-T, CDM-T (excl.)  
 70W

**Material:**  
 Aluminium/steel

**Dimensions:**  
 L/W/H: 20,5/16,8/13,5 cm
**Accessory/Included parts:**
 3Ph-adpater (incl.)  
 Electronic ballast (incl.)  
 Reflector (incl.)  
 Deco ring (excl.)
**Versions:**
 black  
 12° 153640  
 24° 153650  
 48° 153660

## white

 12° 153641  
 24° 153651  
 48° 153661

## silver grey

 12° 153644  
 24° 153654  
 48° 153664
**Art. No.:**

Please select your colour version with the desired angle of radiation. Then you only need a deco ring from the accessory list on the left below. In case you want to change the angle of radiation later on, the corresponding reflectors are available separately (see list on the right below).

**Recommended bulb:**
 70W  
 507130, 3000K, 6600lm  
 507131, 4200K, 12700lm

## ACCESSORY for Sleek Spot G12

**Deco ring**  
 black  
 white  
 silver grey

**Art. No.:**  
 153670  
 153671  
 153674

chrome

153672

**Reflector for Sleek Spot**  
 G12, 70W  
 Aluminium  
 Ø/H: 11/8 cm

**Art. No.:**  
 12° 153681  
 24° 153682  
 48° 153684



**CMH SPOT 35W, GU6,5** Design by CDC

230~

**PROFILIGHT**  
**EFFICIENT**
**Socket/Bulb:**  
 GU6,5/CMH-TC (excl.)  
 35W

**Material:**  
 Aluminium

**Dimensions:**  
 L/W/H: 24/9,5/19 cm

**Accessory/Included parts:**

 3Ph-adaptor (incl.)  
 Electronic ballast (incl.)  
 Deco ring (incl.)  
 Reflector (excl.)

**Versions:**  
 black/chrome  
 white  
 silver grey

**Art. No.:**  
 153710  
 153711  
 153714

chrome

153712

**Recommended bulb:**  
 35W, 3000K, 3300lm  
 507030

Reflectors with various angles of radiation see below.

**CMH-SPOT 70W, G12** Design by CDC

230~

**PROFILIGHT**  
**EFFICIENT**
**Socket/Bulb:**  
 G12/CDM-T (excl.)  
 70W

**Material:**  
 Aluminium

**Dimensions:**  
 L/W/H: 26/9,5/22 cm

**Accessory/Included parts:**

 3Ph-adaptor (incl.)  
 Electronic ballast (incl.)  
 Deco ring (incl.)  
 Reflectors (excl.)

**Versions:**  
 black/chrome  
 white  
 silver grey

**Art. No.:**  
 153730  
 153731  
 153734

**Recommended bulb:**  
 70W, 3000K, 6600lm  
 507130

**Recommended bulb:**  
 70W, 3000K, 7300lm  
 507430

Reflectors with various angles of radiation see below.

**QT-SPOT, GY6,35** Design by CDC

230~

12~

**Socket/Bulb:**  
 GY6,35/QT pin-socket (excl.)  
 20-90W

**Material:**  
 Aluminium

**Dimensions:**  
 L/W/H: 24/9,5/19 cm

**Accessory/Included parts:**

 3Ph-adaptor (incl.)  
 Electronic transformer (incl.)  
 Deco ring (incl.)  
 Reflectors (excl.)

**Versions:**  
 black/chrome  
 white  
 silver grey

**Art. No.:**  
 153750  
 153751  
 153754

**Recommended bulb:**  
 90W, 3000K, 1800lm,  
 512260

**Recommended bulb:**  
 50W, 2700K, 900lm  
 512250

Reflectors with various angles of radiation see below.

**ACCESSORY for Spots**

**Reflector for  
 CMH GU6,5-  
 and QT-Spots**  
 Aluminium, chrome  
 Ø/H: 9,5/8 cm

**Art. No.:**  
 12° 153721  
 24° 153722  
 38° 153723  
 60° 153726

**Reflector  
 for CMH G12-Spot  
 70W**  
 Aluminium  
 Ø/H: 11/9 cm

**Art. No.:**  
 12° 153741  
 24° 153742  
 38° 153743  
 60° 153746







**SKELETTO**

230~



Series: page 288

**Socket/Bulb:**  
 R7s/R7s, 78 mm (excl.)  
 150W max.

**Material:**  
 Steel

**Dimensions:**  
 L/W/H: 17/15,5/5 cm

**Accessory/Included parts:**  
 3Ph-adapter (incl.)

**Versions:**  
 silver grey

**Art. No.:**  
 152404

**Recommended bulb:**  
 100W EnergySaver  $\approx$  150W  
 2700K, 1900lm, EEK=C  
 519215

**NEPRO R7s**

230~



Series: page 158, 288

**Socket/Bulb:**  
 R7s/R7s, 118 mm (excl.)  
 300W max.

**Material:**  
 Aluminium

**Dimensions:**  
 L/W/H: 17,5/11/19,5 cm

**Accessory/Included parts:**  
 3Ph-adapter (incl.)

**Versions:**  
 silver grey

**Art. No.:**  
 152222

**Recommended bulb:**  
 200W EnergySaver  $\approx$  300W  
 2700K, 4000lm, EEK=C  
 519223

**NEPRO 2 R7s**

230~

**Socket/Bulb:**  
 R7s/R7s, 118 mm (excl.)  
 150W max.

**Material:**  
 Aluminium

**Dimensions:**  
 L/W/H: 17/11,5/18,5 cm

**Accessory/Included parts:**  
 3Ph-adapter (incl.)

**Versions:**  
 silver grey

**Art. No.:**  
 153534

**Recommended bulb:**  
 130W EnergySaver  $\approx$  200W  
 2700K, 2600lm, EEK=C  
 519222

**R7s SHOP**

230~

**Socket/Bulb:**  
 R7s/R7s, 118 mm (excl.)  
 300W max.

**Material:**  
 Aluminium/steel

**Dimensions:**  
 L/W/H: 18,5/27,5/14 cm

**Accessory/Included parts:**  
 3Ph-adapter (incl.)  
 Shutters (excl.)

**Versions:**  
 white  
 silver grey

**Art. No.:**  
 152301  
 152304

**Recommended bulb:**  
 200W EnergySaver  $\approx$  300W  
 2700K, 4000lm, EEK=C  
 519223

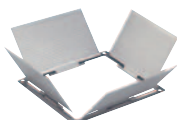
**ACCESSORY for R7s Shop**

**Shutters**  
 white 152311  
 silver grey 152314  
 L/W/H: 28,5/26/2 cm

 Dimensions refer to folded out  
 shutters.

**Art. No.:**  
 152311  
 152314



Art. No.: 153002

**TEC 1 QRB**

**Material:**  
Aluminium

**Accessory/Included parts:**  
3Ph-adapter (incl.)  
Electronic transformer (incl.)

**Recommended bulb:**

35W EnergySaver ≈ 50W  
545512, 6°, 3000K, 22500cd  
545522, 24°, 3000K, 4500cd



Art. No.: 153012

**TEC 2 QRB**

**Material:**  
Aluminium

**Accessory/Included parts:**  
3Ph-adapter (incl.)  
Electronic transformer (incl.)

**Recommended bulb:**

35W EnergySaver ≈ 50W  
545512, 6°, 3000K, 22500cd  
545522, 24°, 3000K, 4500cd



Art. No.: 153022

**TEC 4 QRB**

**Material:**  
Aluminium

**Accessory/Included parts:**  
3Ph-adapter (incl.)  
Electronic transformer (incl.)

**Recommended bulb:**

35W EnergySaver ≈ 50W  
545512, 6°, 3000K, 22500cd  
545522, 24°, 3000K, 4500cd



Art. No.: 153182

**TEC 1 BRITESPOT ES111 GX10**

**Material:**  
Aluminium

**Accessory/Included parts:**  
3Ph-adapter (incl.)  
Electronic ballast (incl.)

**Recommended bulb:**

70W, 3000K, 20000cd  
506982



Art. No.: 153094

**TEC 1 GX10**

**Material:**  
Aluminium

**Accessory/Included parts:**  
3Ph-adapter (incl.)  
Electronic ballast (incl.)

**Recommended bulb:**

35W, 40°, 4200K, 3000cd  
507341

**ACCESSORY for TEC1 GX10**

CMH MR16 Precise™  
Constant Color™, GX10.

3000K	35W	12°	507310
3000K	35W	25°	507320
3000K	35W	40°	507340

4200K	35W	12°	507311
4200K	35W	25°	507321
4200K	35W	40°	507341

**TEC**

Article No.	Description	Colour	Voltage	Socket/ Bulb (excl.)	Wattage bulb	Length in cm	Width in cm	Height in cm	Energy efficiency category ballast	Weight
153002	TEC 1 QRB	silver grey	230V AC/12V AC	G53/QRB111	50W max.	14,0	18,0	19,5	-	0,70 kg
153012	TEC 2 QRB	silver grey	230V AC/12V AC	G53/QRB111	2x 50W max.	14,0	31,5	19,5	-	0,90 kg
153022	TEC 4 QRB	silver grey	230V AC/12V AC	G53/QRB111	4x 50W max.	30,5	31,5	19,5	-	1,50 kg
153182	TEC 1 Britespot ES111 GX10	silver grey	230V AC	GX10/Britespot ES111	70W	14,0	18,0	19,5	EEL=A2	0,80 kg
153094 ▼	TEC 1 GX10	silver grey	230V AC	GX10/CMH-MR16	35W	12,5	9,5	24,0	EEL=A2	0,64 kg





Art. No.: 152154

**PAR MESH 16****Material:**  
Aluminium**Accessory/Included parts:**  
3Ph-adapter (incl.)**Recommended bulb:**  
35W EnergySaver  $\approx$  50W  
20°, 2800K, 1200cd  
575370

Art. No.: 152164

**PAR MESH 20****Material:**  
Aluminium**Accessory/Included parts:**  
3Ph-adapter (incl.)**Recommended bulb:**  
75W, 24°, 5500cd  
519727

Art. No.: 152174

**PAR MESH 30****Material:**  
Aluminium**Accessory/Included parts:**  
3Ph-adapter (incl.)**Recommended bulb:**  
150W, 24°, 11000cd  
519739

PAR MESH Further spotlights can be found under "Stage Factory Line" on pages 196-199.

230~



Article No.	Description	Colour	Voltage	Socket/ Bulb (excl.)	Wattage bulb	Ø in cm	Length in cm	Rotation/ Swivel range	Application range	Weight
152154	PAR Mesh 16	alu	230V AC	GU10/GU10	50W max.	9,0	24,0	350°/170°	Wall, ceiling	0,11
152164	PAR Mesh 20	alu	230V AC	E27/PAR20	75W max.	16,0	27,0	350°/170°	Wall, ceiling	0,55
152174	PAR Mesh 30	alu	230V AC	E27/PAR30	150W max.	18,0	39,0	350°/170°	Ceiling	0,68

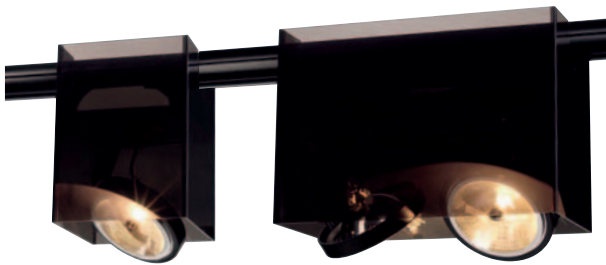

### ACRYLIC BOX QRB111

**Material:**  
PMMA

**Accessory/Included parts:**  
3Ph-adapter (incl.)  
Electronic transformer (incl.)

**Recommended bulb:**  
75W, 24°, 2700K, 3000cd  
543724



**Recommended bulb:**  
50W EnergySaver ≈ 75W  
545752, 24°, 3000K, 5800cd



### ACRYLIC BOX ES111

**Material:**  
PMMA

**Accessory/Included parts:**  
3Ph-adapter (incl.)

**Recommended bulb:**  
75W, 24°, 2700K, 2000cd  
575672



### ACRYLIC BOX QRB111 / ES111

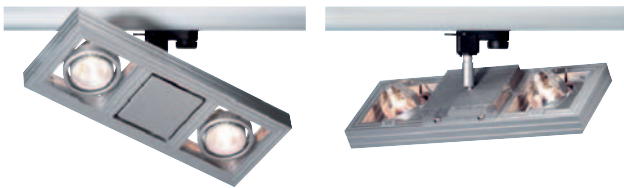

Article No.	Description	Colour	Voltage	Socket/ Bulb (excl.)	Wattage bulb	Length in cm	Width in cm	Height in cm	Weight
153801	Acrylic box 1 QRB111	black/translucent	230V AC/12V AC	G53/QRB111	75W max.	15,0	15,0	20,3	1,00 kg
153802	Acrylic box 2 QRB111	black/translucent	230V AC/12V AC	G53/QRB111	2x 50W max.	29,4	15,0	20,3	1,55 kg
153811	Acrylic box 1 ES111	black/translucent	230V AC	GU10/ES111	75W max.	15,0	15,0	21,4	1,05 kg
153812	Acrylic box 2 ES111	black/translucent	230V AC	GU10/ES111	2x 75W max.	29,5	15,0	21,4	1,65 kg

**KARDATRACK MR16/2** Design by CDC

**Socket/Bulb:**  
GU5,3/MR16 (excl.)  
2x 50W max.

**Material:**  
Aluminium

**Dimensions:**  
L/W/H: 35/13/15 cm

**Accessory/Included parts:**  
3Ph-adaptor (incl.)  
Electronic transformer (incl.)

**Versions:**  
silver grey

**Art. No.:**  
154502

**Recommended bulb:**  
50W, 25°, 2700K, 2450cd  
535527

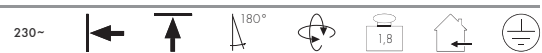
**KARDATRACK GU10/4** Design by CDC

**Socket/Bulb:**  
GU10/GU10 (excl.)  
4x 50W max.

**Material:**  
Aluminium

**Dimensions:**  
L/W/H: 52,5/13/18 cm

**Accessory/Included parts:**  
3Ph-adaptor (incl.)

**Versions:**  
silver grey

**Art. No.:**  
154532

**Recommended bulb:**  
35W EnergySaver ≙ 50W  
20°, 2800K, 1200cd  
575370

**KARDATRACK QRB111/4** Design by CDC

**Socket/Bulb:**  
G53/QRB111 (excl.)  
4x 50W max.

**Material:**  
Aluminium

**Dimensions:**  
L/W/H: 86,5/19/18 cm

**Accessory/Included parts:**  
3Ph-adaptor (incl.)  
Electronic transformer (incl.)

**Versions:**  
silver grey

**Art. No.:**  
154512

**Recommended bulb:**  
50W EnergySaver ≙ 75W  
545752, 24°, 3000K, 5800cd



**AERO PAR30** Design by CDC

230~

**Accessory/Included parts:**  
 3Ph-adapter (incl.)

**Socket/Bulb:**  
 E27/PAR30 (excl.)  
 75W max.

**Versions:**  
 silver grey

**Art. No.:**  
 152417

**Material:**  
 Aluminium/plastic

**Dimensions:**  
 L/W/H: 12/12/15 cm

**Recommended bulb:**  
 75W, 24°, 7000cd  
 519737

**YOKI ES111** Design by CDC/FGI

230~

**Accessory/Included parts:**  
 3Ph-adapter (incl.)  
 Deco ring (incl.)

**Note:**  
 Without the deco ring, the spot can  
 be used with the DomeLED ES111  
 bulb.

**Socket/Bulb:**  
 GU10/ES111 (excl.)  
 75W max.

**Material:**  
 Aluminium

**Dimensions:**  
 L/W/H: 8,5/5/25,5 cm

**Versions:**  
 silver grey

**Art. No.:**  
 153154

**Recommended bulb:**  
 75W, 24°, 2700K, 2000cd  
 575672

**LUNA 1**

230~

**Accessory/Included parts:**  
 3Ph-adapter (incl.)  
 Deco ring (excl.)

**Socket/Bulb:**  
 GU10/ES111 (excl.)  
 75W max.

**Material:**  
 Aluminium

**Dimensions:**  
 W/H: 13/25,5 cm

**Versions:**  
 silver grey

**Art. No.:**  
 152282

**Recommended bulb:**  
 75W, 24°, 2700K, 2000cd  
 575672

**ACCESSORY** for Luna 1

**Deco ring 111 for ES111** Art. No.:  
 silver grey, grooved 151051





## LIGHT EYE PENDANT LUMINAIRE

230~  1,5 m  0,7  

Series: page 038, 135



**Socket/Bulb:**  
GU10/ES1111 (excl.)  
75W max.

**Material:**  
Steel  
Black textile-coated cable

**Dimensions:**  
Ø/H: 15/12 cm

**Accessory/Included parts:**  
3Ph-adapter (incl.)

**Versions:**  
chrome

**Art. No.:**  
153112

**Recommended bulb:**  
75W, 24°, 2700K, 2000cd  
575672



## PIRUS

230~  1,5 m  0,6  



**Socket/Bulb:**  
E14/AGL candle shape (excl.)  
40W max.  
or  
E14/EnergySaver (excl.)  
up to max. Ø/L: 3,8/11,7 cm

**Material:**  
Steel/glass  
Red textile-coated cable

**Dimensions:**  
Head-Ø/H: 14/19 cm

**Accessory/Included parts:**  
3Ph-adapter, black (incl.)

**Versions:**  
chrome  
Glass satined

**Art. No.:**  
153121

**Recommended bulb:**  
11W, 2700K, 530lm, EEK=A  
508810



**LIGHT EYE SPOT**

230~



Series: page 038, 135

**Socket/Bulb:**  
 GU10/ES111 (excl.)  
 75W max.

**Material:**  
 Steel

**Dimensions:**  
 Ø/H: 15/28 cm

**Accessory/Included parts:**  
 3Ph-adapter (incl.)

**Versions:**  
 chrome

**Art. No.:**  
 153102

**Recommended bulb:**  
 75W, 24°, 2700K, 2000cd  
 575672

**Q-TECH® SPOT GU10**

230~

**Socket/Bulb:**  
 GU10/GU10 (excl.)  
 50W max.

**Material:**  
 Aluminium

**Dimensions:**  
 Head-Ø: 6 cm  
 Total-L: 23,5 cm

**Accessory/Included parts:**  
 3Ph-adapter (incl.)

**Versions:**  
 white  
 silver grey

**Art. No.:**  
 153301  
 153304

**Recommended bulb:**  
 35W EnergySaver ≙ 50W  
 20°, 2800K, 1200cd  
 575370

**BIMA 1**

230~

**Socket/Bulb:**  
 GU10/GU10 (excl.)  
 50W max.

**Material:**  
 Aluminium

**Dimensions:**  
 L/W: 19,7/8,3 cm  
 Head-Ø/L: 6/7,8 cm

**Accessory/Included parts:**  
 3Ph-adapter (incl.)

**Versions:**  
 silver grey

**Art. No.:**  
 152242

**Recommended bulb:**  
 35W EnergySaver ≙ 50W  
 20°, 2800K, 1200cd  
 575370

**BIMA 2**

230~

**Socket/Bulb:**  
 GU10/GU10 (excl.)  
 2x 50W max.

**Material:**  
 Aluminium

**Dimensions:**  
 L/W: 19,7/13 cm  
 Head-Ø/L: 6/7,8 cm

**Accessory/Included parts:**  
 3Ph-adapter (incl.)

**Versions:**  
 silver grey

**Art. No.:**  
 152232

**Recommended bulb:**  
 35W EnergySaver ≙ 50W  
 20°, 2800K, 1200cd  
 575370

**AERO GU10** Design by CDC

230~

**Socket/Bulb:**  
 GU10/GU10 (excl.)  
 50W max.

**Material:**  
 Aluminium/plastic

**Dimensions:**  
 L/W/H: 9/9/14,5 cm

**Accessory/Included parts:**  
 3Ph-adapter (incl.)

**Versions:**  
 white  
 silver grey

**Art. No.:**  
 151011  
 151017

**Recommended bulb:**  
 35W EnergySaver ≙ 50W  
 20°, 2800K, 1200cd  
 575370



## TEC TC-DE

230~ Ballast EEI=A2 350° 360° 0,9



**Socket/Bulb:**  
G24q-3/  
TC-DE EnergySaver (excl.)  
26W

**Versions:**  
silver grey ▼

**Art. No.:**  
153062

**Material:**  
Aluminium/glass

**Recommended bulb:**  
26W, 4000K, 1800lm, EEK=B  
508322



**Dimensions:**  
L/W/H: 35/14,5/22 cm

**Accessory/Included parts:**  
3Ph-adapter (incl.)  
Electronic ballast (incl.)

## PL 2/24 SHOP

230~ Ballast EEI=B2 350° 180° 3,0



**Socket/Bulb:**  
2G11/TC-L 2G11 (excl.)  
2x 24W

**Versions:**  
silver grey/black

**Art. No.:**  
152272

**Material:**  
Aluminium/plastic

**Recommended bulb:**  
24W, 4000K, 1800lm, EEK=A  
508441



**Dimensions:**  
L/W/H: 42,7/14/27,5 cm

**Accessory/Included parts:**  
3Ph-adapter (incl.)  
Low-loss ballast (incl.)

## TWINTUBE for 3Phase high-voltage track

230~ Ballast EEI=A2 350° 1,45



**Socket/Bulb:**  
G5/T5 EnergySaver (excl.)  
2x 39W

**Versions:**  
silver grey

**Art. No.:**  
152182

**Material:**  
Housing plastic  
Tube acrylic

**Recommended bulb:**  
39W, 4000K, 3220lm  
548139



**Dimensions:**  
L/W/H: 91/19,5/11,5 cm  
Tube-Ø: 4,3 cm

[PU see page 617]

**Accessory/Included parts:**  
3Ph-adapter (incl.)  
Electronic ballast (incl.)

**NEPRO 2 PL**

230~

**Socket/Bulb:**  
 2G11/TC-L (excl.)  
 36W

**Material:**  
 Aluminium

**Dimensions:**  
 L/W/H: 48/11,5/18,5 cm

**Accessory/Included parts:**  
 Electronic ballast (incl.)

**Versions:**  
 silver grey

**Art. No.:**  
 153544

**Recommended bulb:**  
 36W, 4000K, 2900lm, EEK=A  
 590145

**NEPRO 2 T5**

230~

**Socket/Bulb:**  
 G5/EnergySaver (excl.)  
 2x 24W

**Material:**  
 Aluminium

**Dimensions:**  
 L/W/H: 60,5/12/19 cm

**Accessory/Included parts:**  
 Electronic ballast (incl.)

**Versions:**  
 silver grey

**Art. No.:**  
 153524

**Recommended bulb:**  
 24W, 4000K, 1700lm  
 548124

(PU see page 617)



# EUTRAC®

**Eutrac®-System** The 5 conductor Eutrac® surface track consists of an extruded aluminium profile which also functions as earth and two inserted plastic profiles carrying four embedded 2.5 mm<sup>2</sup> copper conductors. Any given profile can be easily cut to length on site. It is not necessary to cut back or bend back the conductors. The track has pre-punched oval holes and may be used within handreach.

## EUTRAC® 3PHASE RECESSED TRACK

230~

16A max.

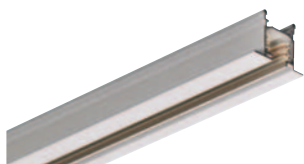

**Note:**  
Flexible suspension at spring clips over arrow-shaped profilings. Support bracket max. 4kg/m loadable.

**Material:**  
Aluminium/plastic

**Versions:**  
white/2 m

**Art. No.:**  
145211

**Dimensions:**  
2m L/W/H: 200/5,9/4,1 cm  
3m L/W/H: 300/5,9/4,1 cm

white/3 m

145311

## ACCESSORY for Eutrac® 3Phase recessed track

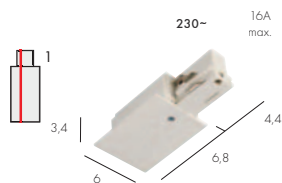

**Eutrac® Feed-in**  
Earth left, white  
Plastic  
With circulating ceiling bearing profile.

**Art. No.:**  
145541

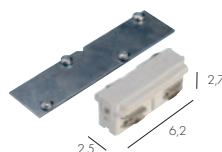

**Eutrac® Longitudinal coupler**  
electr./mech., white  
Steel/plastic  
Inboard.

**Art. No.:**  
145571



**Eutrac® End cap**  
white  
Plastic/steel  
With ceiling bearing profile.  
L/W/H: 2,7/6/3,2 cm  
visible L/W/H: 1,1/6/0,1 cm

**Art. No.:**  
145621

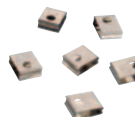

**Eutrac® Spring clip**  
white, 6 pieces  
Steel  
For on-site fast suspending brackets.

**Art. No.:**  
145551

## EUTRAC® 3PHASE SURFACE TRACK

230~

16A max.

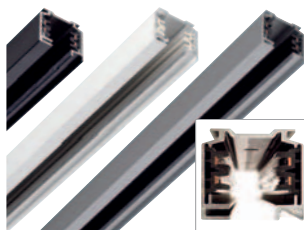

**Material:**  
Aluminium/plastic

**Versions:**  
black/1 m 145100  
white/1 m 145101  
silver grey anodized/1 m 145102

**Art. No.:**  
145100  
145101  
145102

**Versions:**  
black/3 m 145300  
white/3 m 145301  
silver grey anodized/3 m 145302

**Art. No.:**  
145300  
145301  
145302

**Dimensions:**  
1m L/W/H: 100/3,6/3,2 cm  
2m L/W/H: 200/3,6/3,2 cm  
3m L/W/H: 300/3,6/3,2 cm

black/2 m 145200  
white/2 m 145201  
silver grey anodized/2 m 145202

## ACCESSORY for Eutrac® 3Phase surface track

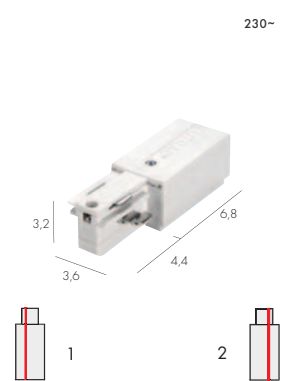

**Feed-in 1, earth left**  
black 145510  
white 145511

silver grey 145514

**Feed-in 2, earth right**  
black 145520  
white 145521

silver grey 145524

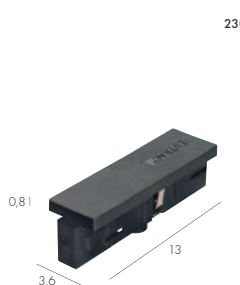

**Middle feed-in**  
black 145530  
white 145531

silver grey 145534

Plastic  
Can be positioned at any part of the track. Not suitable as longitudinal coupler.

Also suitable for Eutrac® 3Phase recessed track

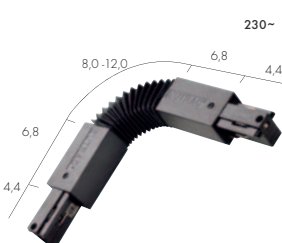

**Flex coupler**  
black 145580  
white 145581

Plastic  
For radius of 30°-330°.  
With feed-in possibility.

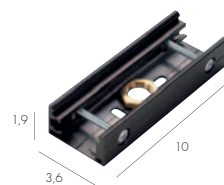

**Pendant coupler**  
black 145600  
white 145601  
silver grey 145604

Aluminium  
With suspension possibility for rope and pendant suspension Ø 13 mm.

 <p>230~ 16A max.</p> <p>2,6 1,5 5,8</p>	<p>16A max.    </p> <p><b>Longitud. coupler, electrical</b> Art. No.: black 145560 white 145561</p> <p>silver grey 145564</p> <p>Plastic Inboard. In case of pendant suspension, the pendant coupler is due to static reasons additionally needed. (145600/-1/-4)</p>	 <p>230~ 16A max.    </p> <p>3,2 3,6 4,4 17,2 4,4</p>	<p>16A max.    </p> <p><b>Longitudinal coupler</b> Art. No.: black 145660 white 145661</p> <p>silver grey 145664</p> <p>Plastic With feed-in possibility.</p>
 <p>230~ 16A max.    </p> <p>4,4 10,5 3,2 10,5 4,4</p> <p>1 2</p>	<p><b>L-coupler 1, earth outside</b> Art. No.: black 145670 white 145671</p> <p>silver grey 145674</p> <p><b>L-coupler 2, earth inside</b> black 145680 white 145681</p> <p>silver grey 145684</p>	 <p>230~ 16A max.    </p> <p>4,4 10,5 3,2 4,4 17,2 3,6 4,4</p> <p>1 2</p>	<p><b>T-coupler 1, earth right</b> Art. No.: black 145640 white 145641</p> <p>silver grey 145644</p> <p><b>T-coupler 2, earth left</b> black 145630 white 145631</p> <p>silver grey 145634</p>
 <p>230~ 16A max.    </p> <p>4,4 17,2 4,4 3,2 3,6</p>	<p><b>X-coupler</b> Art. No.: black 145690 white 145691</p> <p>silver grey 145694</p> <p>Plastic With feed-in possibility. 2 power circuits.</p>	 <p>230~ 6,3A max.    </p> <p>5,5 6,5</p>	<p><b>Power socket adapter</b> Art. No.: black 145700 cream white 145701</p> <p>Plastic With feed-in possibility. For the connection of devices with protection class I (system Schuko) or universally applicable for device flat plugs with protection class II, for mains voltage 220-240V with fuse 6,3A.</p> <p>Also suitable for Eutrac® 3Phase recessed track</p>
 <p>230~ 10A max. 5kg max.   </p>	<p><b>Lamp adapter</b> Art. No.: black 145990 white 145991 silver grey 145994</p> <p>Polyamide 66 Threaded piece (incl.) Strain relief (incl.)</p> <p>Also suitable for Eutrac® 3Phase recessed track</p>	 <p>230~ 10kg max.   </p>	<p><b>Lamp adapter, mech.</b> Art. No.: black 144980 white 144981 silver grey 144984</p> <p>Aluminium Thread M8</p> <p>Also suitable for Eutrac® 3Phase recessed track</p>
 <p>1,9 3,6 5,0</p>	<p><b>Pendant clip</b> Art. No.: black 145730 white 145731</p> <p>silver grey 145734</p> <p>Aluminium For suspension via rope or pendant suspension.</p>	 <p>3,6 0,2 3,2</p>	<p><b>End cap</b> Art. No.: black 145590 white 145591</p> <p>silver grey 145594</p> <p>Plastic</p>
	<p><b>Pendant rod fixed</b> Art. No.: 0,6 m, 0,28 kg, black 145720 0,6 m, 0,28 kg, white 145721</p> <p>0,6 m, 0,28 kg, silver grey 145724</p> <p>1,2 m, 0,49 kg, black 145710 1,2 m, 0,49 kg, white 145711</p> <p>1,2 m, 0,49 kg, silver grey 145714</p> <p>Can be cut on site, to use with pendant clip (see above).</p>		<p><b>Wire rope suspension</b> Art. No.: 1,5 m, 0,05 kg, chrome 145800</p> <p>3 m, 0,1 kg, chrome 145810</p> <p>6,2 m, 0,2 kg, chrome 145820</p>
	<p><b>Ceiling canopy</b> Art. No.: black 145740 white 145741 silver grey 145744</p> <p>Load max. 10 kg Ø/H: 12,5/6,2 cm</p>		

# 1 PHASE TRACK SYSTEM

Spotlights for  
low-voltage bulbs  
QRB111



Spotlights for  
high-voltage bulbs  
GU10

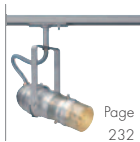

Spotlights for  
high-voltage bulbs  
ES111



Spotlights for  
high-voltage bulbs  
R7s



Spotlights for  
high-voltage bulbs  
PAR

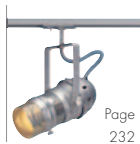

Energy-Saver



Professional spots  
for the commercial  
use.

**EFFICIENT**  
**PROFI**light.



**EURO SPOT ES111**

230~

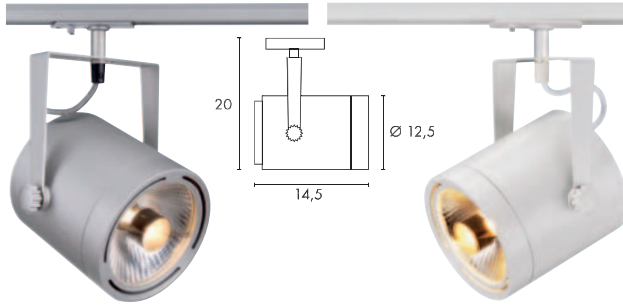
**Socket/Bulb:**  
 GU10/ES111 (excl.)  
 75W max.

**Material:**  
 Aluminium

**Accessory/Included parts:**  
 1 Ph-adapter (incl.)

**Versions:**  
 white  
 silver grey

**Art. No.:**  
 143801  
 143804

**Recommended bulb:**  
 75W, 4000K, 2500cd  
 575671

**SKELETTO**

230~



Series: page 288

**Socket/Bulb:**  
 R7s/R7s, 78 mm (excl.)  
 150W max.

**Material:**  
 Steel

**Dimensions:**  
 L/W/H: 17/15,5/5 cm

**Accessory/Included parts:**  
 1 Ph-adapter (incl.)

**Versions:**  
 white  
 silver grey

**Art. No.:**  
 143321  
 143327

**Recommended bulb:**  
 100W EnergySaver 4 150W  
 2700K, 1900lm, EEK=C  
 519215

**AERO PAR30** Design by CDC

230~

**Socket/Bulb:**  
 E27/PAR30 (excl.)  
 75W max.

**Material:**  
 Aluminium

**Dimensions:**  
 L/W/H: 12/12/15 cm

**Accessory/Included parts:**  
 1 Ph-adapter (incl.)

**Versions:**  
 silver grey

**Art. No.:**  
 143317

**Recommended bulb:**  
 75W, 24°, 7000cd  
 519737

**Q-TECH® SPOT G12 HOR**

230~

**PROFICIENT**  
 light.

**Socket/Bulb:**  
 G12/HQ-T; CDM-T (excl.)  
 70W

**Material:**  
 Aluminium

**Dimensions:**  
 Head-Ø: 12 cm  
 W/H: 30,5/16 cm

**Accessory/Included parts:**  
 1 Ph-adapter (incl.)  
 Electronic ballast (incl.)  
 Reflector (excl.)  
 Suitable reflector see below.

**Versions:**  
 white  
 silver grey

**Art. No.:**  
 143671  
 143674

**Recommended bulb:**  
 70W, 4200K, 12700lm  
 507131

**ACCESSORY for Q-Tech® G12**

**Reflector**  
 Aluminium  
 Product-Ø: 10,5 cm

**Art. No.:**  
 24° 153241  
 44° 153244  
 60° 153246





Art. No.: 143512

**TEC 1 QRB****Material:**  
Aluminium**Accessory/Included parts:**  
1 Ph-adapter (incl.)  
Electronic transformer (incl.)**Recommended bulb:**35W EnergySaver  $\approx$  50W  
545512, 6°, 3000K, 22500cd  
545522, 24°, 3000K, 4500cd

Art. No.: 143522

**TEC 2 QRB****Material:**  
Aluminium**Accessory/Included parts:**  
1 Ph-adapter (incl.)  
Electronic transformer (incl.)**Recommended bulb:**35W EnergySaver  $\approx$  50W  
545512, 6°, 3000K, 22500cd  
545522, 24°, 3000K, 4500cd

Art. No.: 143532

**TEC 4 QRB****Material:**  
Aluminium**Accessory/Included parts:**  
1 Ph-adapter (incl.)  
Electronic transformer (incl.)**Recommended bulb:**35W EnergySaver  $\approx$  50W  
545512, 6°, 3000K, 22500cd  
545522, 24°, 3000K, 4500cd**TEC QRB**

Article No.	Description	Colour	Voltage	Socket/ Bulb (excl.)	Wattage bulb	Length in cm	Width in cm	Height in cm	Weight
143512	TEC 1 QRB	silver grey	230V AC/12V AC	G53/QRB111	50W max.	14,0	18,0	16,0	0,7 kg
143522	TEC 2 QRB	silver grey	230V AC/12V AC	G53/QRB111	2x 50W max.	14,0	31,5	16,0	0,9 kg
143532 ▼	TEC 4 QRB	silver grey	230V AC/12V AC	G53/QRB111	4x 50W max.	30,5	31,5	16,0	1,5 kg



Art. No.: 143704

**PAR MESH 16****Material:**  
Aluminium**Accessory/Included parts:**  
1 Ph-adapter (incl.)**Recommended bulb:**35W EnergySaver  $\approx$  50W  
20°, 2800K, 1200cd  
575370

Art. No.: 143714

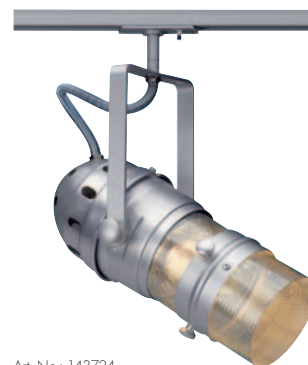
**PAR MESH 20****Material:**  
Aluminium**Accessory/Included parts:**  
1 Ph-adapter (incl.)**Recommended bulb:**75W, 24°, 5500cd  
519727

Art. No.: 143724

**PAR MESH 30****Material:**  
Aluminium**Accessory/Included parts:**  
1 Ph-adapter (incl.)**Recommended bulb:**150W, 24°, 11000cd  
519739**PAR MESH**

Article No.	Description	Colour	Voltage	Socket/ Bulb (excl.)	Wattage Bulb	Ø in cm	Length in cm	Rotation/ swivel range	Application range	Weight
143704	PAR Mesh 16	alu	230V AC	GU10/GU10	50W max.	9,0	24,0	350°/170°	Wall, ceiling	0,33 kg
143714	PAR Mesh 20	alu	230V AC	E27/PAR20	75W max.	16,0	27,0	350°/170°	Ceiling	0,51 kg
143724	PAR Mesh 30	alu	230V AC	E27/PAR30	150W max.	18,0	39,0	350°/170°	Ceiling	0,69 kg

**BIMA 1**

**Socket/Bulb:**  
GU10/GU10 (excl.)  
50W max.

**Versions:**  
silver grey

**Art. No.:**  
143442

**Material:**  
Aluminium

**Recommended bulb:**  
35W EnergySaver  $\approx$  50W  
20°, 2800K, 1200cd  
575370



**Dimensions:**  
L/W: 19,7/8,3 cm  
Head-Ø/L: 6/7,8 cm

**Accessory/Included parts:**  
1 Ph-adapter (incl.)

**BIMA 2**

**Socket/Bulb:**  
GU10/GU10 (excl.)  
2x 50W max.

**Versions:**  
silver grey

**Art. No.:**  
143432

**Material:**  
Aluminium

**Recommended bulb:**  
35W EnergySaver  $\approx$  50W  
20°, 2800K, 1200cd  
575370



**Dimensions:**  
L/W: 19,7/13 cm  
Head-Ø/L: 6/7,8 cm

**Accessory/Included parts:**  
1 Ph-adapter (incl.)



## KASPO

230~



**Socket/Bulb:**  
GU10/GU10 (excl.)  
50W max.

**Material:**  
Aluminium

**Dimensions:**  
W/H/D: 7/31,5/8,5 cm  
Head-Ø: 5,5 cm

**Accessory/Included parts:**  
1Ph-adapter (incl.)

**Versions:**  
silver grey

**Art. No.:**  
143422

**Recommended bulb:**  
35W EnergySaver  $\approx$  50W  
20°, 2800K, 1200cd  
575370



## Q-TECH® SPOT GU10

230~



**Socket/Bulb:**  
GU10/GU10 (excl.)  
50W max.

**Material:**  
Aluminium

**Dimensions:**  
Head-Ø: 6 cm  
Total-H: 21,5 cm

**Accessory/Included parts:**  
1Ph-adapter (incl.)

**Versions:**  
white  
silver grey

**Art. No.:**  
143631  
143634

**Recommended bulb:**  
35W EnergySaver  $\approx$  50W  
20°, 2800K, 1200cd  
575370



## BLOX

230~



**Socket/Bulb:**  
GU10/GU10 (excl.)  
50W max.

**Material:**  
Aluminium/glass

**Dimensions:**  
L/W: 10,5/15,5 cm

**Accessory/Included parts:**  
1Ph-adapter (incl.)

**Versions:**  
silver grey

**Art. No.:**  
143502

**Recommended bulb:**  
35W EnergySaver  $\approx$  50W  
20°, 2800K, 1200cd  
575370



## TOBU

230~



**Socket/Bulb:**  
GU10/GU10 (excl.)  
50W max.

**Material:**  
Steel/glass

**Dimensions:**  
L/W/H: 16,5/8/6 cm

**Accessory/Included parts:**  
1Ph-adapter (incl.)

**Versions:**  
silver grey  
Glass partial satined

**Art. No.:**  
143372

**Recommended bulb:**  
35W EnergySaver  $\approx$  50W  
20°, 2800K, 1200cd  
575370



## AERO GU10 Design by CDC

230~



**Socket/Bulb:**  
GU10/GU10 (excl.)  
50W max.

**Material:**  
Aluminium/plastic

**Dimensions:**  
L/W/H: 7/7/11 cm

**Accessory/Included parts:**  
1Ph-adapter (incl.)

**Versions:**  
white  
silver grey

**Art. No.:**  
143301  
143307

**Recommended bulb:**  
35W EnergySaver  $\approx$  50W  
20°, 2800K, 1200cd  
575370



**PURI**

230~



**Socket/Bulb:**  
GU10/GU10; ES111 (excl.)  
50W max.

**Material:**  
Aluminium/plastic

**Dimensions:**  
L/W/H: 8/3,5/9 cm  
Head-Ø/L: 3,5/3,5 cm

**Accessory/Included parts:**  
1 Ph-adapter (incl.)

**Note:**  
Deco ring for the GU10 bulb is included in the delivery.  
The Puri spot can be equipped with GU10 or ES111 bulbs.

**Versions:**  
white  
silver grey

**Art. No.:**  
143391  
143392

**Recommended bulb:**  
35W EnergySaver ≈ 50W  
20°, 2800K, 1200cd  
575370

**KASPO ES111**

230~



**Socket/Bulb:**  
GU10/ES111 (excl.)  
75W max.

**Material:**  
Aluminium

**Dimensions:**  
Head-Ø/H: 12,7/18 cm

**Accessory/Included parts:**  
1 Ph-adapter (incl.)

**Versions:**  
silver grey

**Art. No.:**  
143754

**Recommended bulb:**  
75W, 24°, 2700K, 2000cd  
575672

**LUNA 1**

230~



**Application example:**  
Luna 1 with DomeLED 9W bulb  
(550392).

**Socket/Bulb:**  
GU10/ES111 (excl.)  
75W max.  
or  
DomeLED ES111 (excl.)  
9W

**Material:**  
Aluminium

**Dimensions:**  
W/H/D: 7,5/21/4 cm

**Accessory/Included parts:**  
1 Ph-adapter (incl.)  
Deco ring (excl.)

**Versions:**  
silver grey

**Art. No.:**  
143482

**Recommended bulb:**  
75W, 24°, 2700K, 2000cd  
575672



**Recommended bulb:**  
DomeLED 9W, 60°, 176lm  
550392 warm white

**ACCESSORY for Luna 1**

**Deco ring 111 for ES111** Art. No.:  
silver grey, grooved 151051

Not suitable for DomeLED  
bulbs.



## TONGA 4

230~



**Socket/Bulb:**  
E14/AGL (excl.)  
60W max.  
or  
E14/EnergySaver (excl.)  
up to max. Ø/L: 5/13 cm

**Material:**  
Ceramic

**Dimensions:**  
Ø/H: 15/22 cm

**Accessory/Included parts:**  
1 Ph-adapter (incl.)

**Versions:**  
Shade white

**Art. No.:**  
143594

**Recommended bulb:**  
11W, 2700K, 530lm, EEK=A  
508810



## PIRUS

230~



**Socket/Bulb:**  
E14/AGL candle shape (excl.)  
40W max.  
or  
E14/EnergySaver (excl.)  
up to max. Ø/L: 3,8/11,7 cm

**Material:**  
Steel/glass  
Red textile-coated cable

**Dimensions:**  
Ø/H: 14/19 cm

**Accessory/Included parts:**  
1 Ph-adapter (incl.)

**Versions:**  
chrome

**Art. No.:**  
143601

**Recommended bulb:**  
11W, 2700K, 530lm, EEK=A  
508810



## TWINTUBE

230~

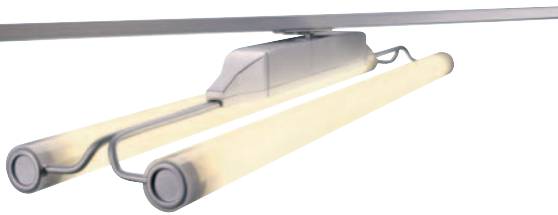

**Socket/Bulb:**  
G5/T5 EnergySaver (excl.)  
2x 39W

**Material:**  
Housing plastic  
Tube acrylic

**Dimensions:**  
L/W/H: 91/19,5/10 cm  
Tube-Ø: 4,3 cm

**Accessory/Included parts:**  
1 Ph-adapter (incl.)  
Electronic ballast (incl.)

**Versions:**  
silver grey

**Art. No.:**  
143402

**Recommended bulb:**  
39W, 3000K, 3500lm  
548039

(PU see page 617)



## TEC TC-DE

230~



**Socket/Bulb:**  
G24q-3/TC-DE (excl.)  
26W

**Material:**  
Aluminium/glass

**Dimensions:**  
L/W/H: 35/14,5/22 cm

**Accessory/Included parts:**  
1 Ph-adapter (incl.)  
Electronic ballast (incl.)

**Versions:**  
silver grey ▼

**Art. No.:**  
143582

**Recommended bulb:**  
26W, 4000K, 1800lm, EEK=B  
508322



**1PHASE TRACK, 2 m**

230~

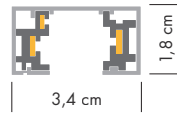
 16A  
max.

**Material:**  
Aluminium

**Versions:**  
white  
silver grey

**Art. No.:**  
143021  
143022

**Dimensions:**  
L/W/H: 200/3,4/1,8 cm  
Conductor cross-section: 4 mm<sup>2</sup>
**ACCESSORY for 1Phase high-voltage track**

1

2

230~ 10A max.

**Feed-in 1, earth left** Art. No.:

white 143031

silver grey 143032

**Feed-in 2, earth right** Art. No.:

white 143041

silver grey 143042

Visible L/W/H: 6,5/3,4/1,8 cm  
Total-L: 10,5 cm

230~ 10A max.

**Longitudinal coupler with feed-in possibility.** Art. No.:

white 143101

silver grey 143102

Visible L/W/H: 9,5/3,4/1,8 cm  
Total-L: 17,5 cm

230~ 10A max.

**Longitud. coupler, electrical** Art. No.:

white 143091

silver grey 143092

Visible L/W/H: 0,4/3,4/1,8 cm  
Total-L: 6,4 cm

230~ 10A max.

**Flex coupler** Art. No.:

white 143111

silver grey 143112

Visible L/W/H: 16,1/3,4/1,8 cm  
Total-L: 23,7 cm  
Bending radius from 70°-180°.

1

2

230~ 10A max.

**L-coupler 1, earth outside** Art. No.:

white 143051

silver grey 143052

**L-coupler 2, earth inside** Art. No.:

white 143061

silver grey 143062

With feed-in possibility.  
Visible L/W/H: 6,5/6,5/1,8 cm  
Total-L: 10,5 cm

1

2

230~ 10A max.

**T-coupler 1, earth left** Art. No.:

white 143071

silver grey 143072

**T-coupler 2, earth right** Art. No.:

white 143081

silver grey 143082

With feed-in possibility.  
Visible L/W/H: 9,5/6,5/1,8 cm  
Total-L: 17 cm

**End cap** Art. No.:

white/2 pce. 143131

silver grey/2 pce. 143132

L/W/H: 0,4/3,4/1,8 cm

**Ceiling suspension** Art. No.:

white 143141

silver grey 143142

L: 3m  
Base-Ø/H: 1,4/2 cm

230~ 6A max.

**1 Ph pendant lamp adapter** Art. No.:

white 143121

silver grey 143124

Mech. load 20N max.  
Threaded piece (incl.)  
Strain relief (incl.)

L/W/H: 8,2/3,5/4,2 cm  
Visible L/W/H: 8,2/3,5/2,7 cm

# EASYTEC® II CHROME/BLACK

Spotlights for  
Easytec® II chrome



Pendant luminaires  
for Easytec® II  
chrome



# EASYTEC® II SILVER GREY

Spotlights for  
Easytec® II  
silver grey

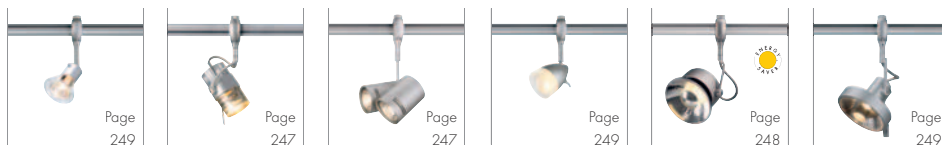
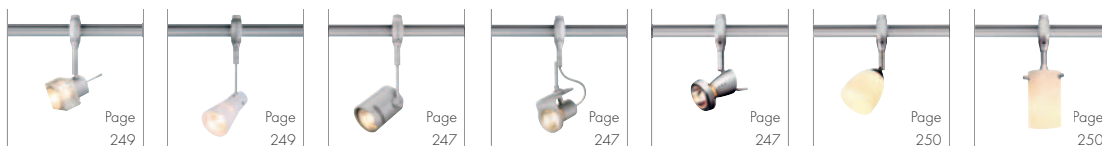

Pendant luminaires  
for Easytec® II  
silver grey





**WĪN**

chassagne blanc	1,90
chassagne rouge	2,30
chassagne rose	2,30
chassagne blanc	1,90
chassagne rouge	2,30
chassagne rose	2,30
chassagne blanc	1,90
chassagne rouge	2,30
chassagne rose	2,30
chassagne blanc	1,90
chassagne rouge	2,30
chassagne rose	2,30

**THEE**

thee	1,30
thee	1,30
thee	1,30
thee	1,30
thee	1,30
thee	1,30
thee	1,30
thee	1,30
thee	1,30
thee	1,30
thee	1,30
thee	1,30

**KOFFIE**

hollis	1,70
calabone	2,00
wokland	2,00
cappuccino	2,00
hollis aller op en aw	1,70
hollis	1,70
hollis	1,70
hollis	1,70
hollis	1,70
hollis	1,70
hollis	1,70
hollis	1,70

**DRANKEN**

red bull	1,60
rustica	1,60
chassfontaine	1,60
chassfontaine	1,60
assembl	1,60
fasti	1,60
Monte maid	1,60
Boyl	1,70
Harv	1,70
shurppes agn	1,70





## LIGHT EYE PENDANT

230~

**Socket/Bulb:**  
 GU10/ES111 (excl.)  
 75W max.

**Material:**  
 Steel  
 Black textile cable

**Dimensions:**  
 Head-Ø/H: 14,5/14,5 cm

**Accessory/Included parts:**  
 Easytec® II-pendant lamp  
 adapter (incl.)

**Versions:**  
 chrome/black

**Art. No.:**  
 185590

**Recommended bulb:**  
 75W, 24°, 2700K, 2000cd  
 575672

## LIGHT EYE ES111 SPOT

230~

**Socket/Bulb:**  
 GU10/ES111 (excl.)  
 75W max.

**Material:**  
 Steel

**Dimensions:**  
 Head-Ø/H: 14,5/26 cm

**Accessory/Included parts:**  
 Easytec® II-adapter (incl.)

**Versions:**  
 chrome/black

**Art. No.:**  
 185580

**Recommended bulb:**  
 75W, 24°, 2700K, 2000cd  
 575672

## LIGHT EYE PENDANT

Series: page 038, 135



230~

**Socket/Bulb:**  
 GU10/ES111 (excl.)  
 75W max.

**Material:**  
 Steel  
 Black textile cable

**Dimensions:**  
 Head-Ø/H: 14,5/14,5 cm

**Accessory/Included parts:**  
 Easytec® II-pendant lamp  
 adapter (incl.)

**Versions:**  
 chrome

**Art. No.:**  
 185592

**Recommended bulb:**  
 75W, 24°, 2700K, 2000cd  
 575672

## LIGHT EYE ES111 SPOT

230~



Series: page 038, 135

**Socket/Bulb:**  
 GU10/ES111 (excl.)  
 75W max.

**Material:**  
 Steel

**Dimensions:**  
 Head-Ø/H: 14,5/26 cm

**Accessory/Included parts:**  
 Easytec® II-adapter (incl.)

**Versions:**  
 chrome

**Art. No.:**  
 185582

**Recommended bulb:**  
 75W, 24°, 2700K, 2000cd  
 575672

## LIGHT EYE GU10 SPOT

230~

**Socket/Bulb:**  
 GU10/GU10 (excl.)  
 50W max.

**Material:**  
 Steel

**Dimensions:**  
 W/H: 10/20 cm  
 Head-Ø: 9 cm

**Accessory/Included parts:**  
 Easytec® II-adapter (incl.)

**Versions:**  
 chrome

**Art. No.:**  
 185692

**Recommended bulb:**  
 35W EnergySaver ± 50W  
 20°, 2800K, 1200cd  
 575370

## ANABA

230~



**Socket/Bulb:**  
GU10/GU10 (excl.)  
50W max.

**Material:**  
Ceramic

**Dimensions:**  
Ø/L: 6,3/24 cm

**Accessory/Included parts:**  
Easytec® II-adapter (incl.)

**Versions:**  
chrome/black

**Art. No.:**  
185650

**Recommended bulb:**  
35W EnergySaver ± 50W  
20°, 2800K, 1200cd  
575370



## BIMA 1

230~



**Socket/Bulb:**  
GU10/GU10 (excl.)  
50W max.

**Material:**  
Aluminium

**Dimensions:**  
W/H: 7,5/23 cm  
Head-Ø/H: 6/8 cm

**Accessory/Included parts:**  
Easytec® II-adapter (incl.)

**Versions:**  
chrome/black

**Art. No.:**  
185450

**Recommended bulb:**  
35W EnergySaver ± 50W  
20°, 2800K, 1200cd  
575370



## RAKA SPOT Design by CDC

230~



**Socket/Bulb:**  
GU10/GU10 (excl.)  
50W max.

**Material:**  
Aluminium/steel

**Dimensions:**  
L/W/H: 9/6/24 cm

**Accessory/Included parts:**  
Easytec® II-adapter (incl.)

**Versions:**  
chrome/black

**Art. No.:**  
185712

**Recommended bulb:**  
35W EnergySaver ± 50W  
20°, 2800K, 1200cd  
575370



**Recommended bulb:**  
PowerLED 3W, 150lm  
550842, warm white



## GX53 SPOT

230~



**Socket/Bulb:**  
GX53/GX53 EnergySaver (excl.)  
13W max.  
or LED GX53, 1,2W (excl.)  
or PowerLED GX53, 3x 1,4W (excl.)  
or Shoplight GX53 11W (excl.)

**Material:**  
Steel

**Dimensions:**  
L/W/Ø: 21/10,5/9 cm

**Accessory/Included parts:**  
Easytec® II-adapter (incl.)

**Versions:**  
chrome

**Art. No.:**  
185742

**Recommended bulb:**  
9W, 2700K, 260lm  
508860



**Recommended bulb:**  
11W, 3000K, 400cd  
508550



**YOKI ES111** Design by CDC/FGL

230~



Without deco ring suitable for DomeLED ES111 bulb.

**Socket/Bulb:**  
 GU10/ES111 (excl.)  
 75W max.

**Material:**  
 Aluminium

**Dimensions:**  
 L/W/H: 8,5/5/25,5 cm

**Accessory/Included parts:**  
 Easytec® II-adapter (incl.)  
 Deco ring (incl.)

**Versions:**  
 chrome

**Art. No.:**  
 185622

**Recommended bulb:**  
 75W, 24°, 2700K, 2000cd  
 575672

**SIENA**

230~

**Socket/Bulb:**  
 GU10/GU10; ES111 (excl.)  
 75W max.

**Material:**  
 Aluminium

**Dimensions:**  
 Ø/L: 4,4/15,5 cm

**Accessory/Included parts:**  
 Easytec® II-adapter (incl.)  
 Deco ring for GU10 (incl.)

**Note:**  
 Deco ring for ES111 see below.

**Versions:**  
 chrome

**Art. No.:**  
 185092

**Recommended bulb:**  
 35W EnergySaver ÷ 50W  
 20°, 2800K, 1200cd  
 575370

**Recommended bulb:**  
 75W, 24°, 2700K, 2000cd  
 575672

**ACCESSORY** for Siena

**Deco ring 111 for ES111** Art. No.:  
 chrome ▼ 111572



## BIBA 3

230~



1,5 m



0,85



**Socket/Bulb:**  
E14/AGL (excl.)  
60W max.  
or  
E14/EnergySaver (excl.)  
up to max. Ø/H: 5/13 cm

**Material:**  
Steel/glass

**Dimensions:**  
Glass-Ø/H: 13/26 cm

**Accessory/Included parts:**  
Easytec® II-pendant lamp  
adapter (incl.)

**Versions:**  
chrome  
Glass satined

**Art. No.:**  
185521

**Recommended bulb:**  
11W, 2700K, 530lm, EEK=A  
508810



## PIRUS

230~



1,5 m



0,53



**Socket/Bulb:**  
E14/AGL candle shape (excl.)  
40W max.  
or  
E14/EnergySaver (excl.)  
up to max. Ø/L: 3,8/11,7 cm

**Material:**  
Steel/glass  
Red textile-coated cable

**Dimensions:**  
Head-Ø/H: 14/19 cm

**Accessory/Included parts:**  
Easytec® II-pendant lamp  
adapter (incl.)

**Versions:**  
chrome  
Glass satined

**Art. No.:**  
185221

**Recommended bulb:**  
11W, 2700K, 530lm, EEK=A  
508810





GX53 Spot, chrome (185742) see page 242 ↑

**ACCESSORY for Easytec® II, chrome/black**

<p>230~ 10A max.</p> <p>↑+A</p> <p>←+A</p> <p>Ⓢ</p> <p>1.0</p> <p>⏚</p>	<p><b>Track</b> black, 1 pce. Aluminium L/W/H: 200/1/3 cm 2 chrome end caps (incl.)</p> <p>Art. No.: 185020</p>		<p><b>Feed-in</b> chrome, 1 pce. Aluminium/glass L/W/H: 7,5/7,5/6 cm Cable-L: 40 cm</p> <p>Art. No.: 185002</p>
	<p><b>Ceiling suspension 10 cm</b> chrome, 1 pce. L: 10 cm</p> <p>Art. No.: 185042</p>		<p><b>Ceiling suspension, flexible</b> chrome, 1 pce. L: adjustable 18-26 cm</p> <p>Art. No.: 185062</p>
	<p><b>Longitudinal coupler</b> chrome, 1 pce.</p> <p>Art. No.: 185032</p>		<p><b>Insulating coupler</b> chrome, 1 pce.</p> <p>Art. No.: 185172</p> <p>For the use of 2 separate circuits.</p>
	<p><b>Flexible coupler</b> chrome, 1 pce. L/W/H: 21,5/3/4 cm</p> <p>Art. No.: 185302</p>		<p><b>Pendant lamp adapter</b> chrome, 1 pce. Load 0,7 kg max. L: 13 cm</p> <p>Art. No.: 185294</p> <p>Only for lamps with protection class 2.</p>
	<p><b>End caps</b> chrome, 2 pce.</p> <p>Art. No.: 185142</p>		<p><b>Bending machine</b> for radius-Ø: &gt; 50 cm</p> <p>Art. No.: 184000</p>



**RAKA SPOT** Design by CDC

230~

**Socket/Bulb:**  
 GU10/GU10 (excl.)  
 50W max.

**Material:**  
 Aluminium/steel

**Dimensions:**  
 L/W/H: 9/6/24 cm

**Accessory/Included parts:**  
 Easytec® II-adapter (incl.)

**Versions:**  
 silver grey ▼

**Art. No.:**  
 184714

**Recommended bulb:**  
 35W EnergySaver ≙ 50W  
 20°, 2800K, 1200cd  
 575370

**SIENA**

230~

**Socket/Bulb:**  
 GU10/GU10; ES111 (excl.)  
 75W max.

**Material:**  
 Aluminium

**Dimensions:**  
 Ø/L: 4,4/15,5 cm

**Accessory/Included parts:**  
 Easytec® II-adapter (incl.)  
 Deco ring for GU10 (incl.)

**Versions:**  
 silver grey

**Art. No.:**  
 184092

**Recommended bulb:**  
 35W EnergySaver ≙ 50W  
 20°, 2800K, 1200cd  
 575370

**LIMA**

230~

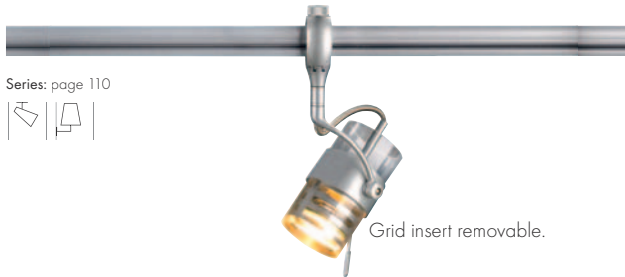
**Socket/Bulb:**  
 GU10/GU10 (excl.)  
 50W max.

**Material:**  
 Aluminium

**Dimensions:**  
 L/W/D: 22/10/12 cm  
 Glass-Ø: 6 cm

**Accessory/Included parts:**  
 Easytec® II-adapter (incl.)

**Versions:**  
 silver grey

**Art. No.:**  
 184492

**Recommended bulb:**  
 35W EnergySaver ≙ 50W  
 20°, 2800K, 1200cd  
 575370

**BIMA 1**

230~

**Socket/Bulb:**  
 GU10/GU10 (excl.)  
 50W max.

**Material:**  
 Aluminium

**Dimensions:**  
 W/H: 7,5/23 cm  
 Head-Ø/H: 6/8 cm

**Accessory/Included parts:**  
 Easytec® II-adapter (incl.)

**Versions:**  
 silver grey

**Art. No.:**  
 184452

**Recommended bulb:**  
 35W EnergySaver ≙ 50W  
 20°, 2800K, 1200cd  
 575370

**BIMA 2**

230~

**Socket/Bulb:**  
 GU10/GU10 (excl.)  
 2x 50W max.

**Material:**  
 Aluminium

**Dimensions:**  
 W/H: 13/23 cm  
 Head-Ø/H: 6/8 cm

**Accessory/Included parts:**  
 Easytec® II-adapter (incl.)

**Versions:**  
 silver grey

**Art. No.:**  
 184442

**Recommended bulb:**  
 35W EnergySaver ≙ 50W  
 20°, 2800K, 1200cd  
 575370





## GX53 SPOT

230~



**Socket/Bulb:**  
GX53/GX53 EnergySaver (excl.)  
13W max.  
or LED GX53, 1,2W (excl.)  
or PowerLED GX53, 3x 1,4W (excl.)  
or Shoplight GX53 11W (excl.)

**Material:**  
Steel

**Dimensions:**  
L/W/Ø: 21/10,5/9 cm

**Accessory/Included parts:**  
Easytec® II-adapter (incl.)

**Versions:**  
silver grey ▼

**Art. No.:**  
184744

**Recommended bulb:**  
9W, 2700K, 260lm  
508860



**Recommended bulb:**  
11W, 3000K, 400cd  
508550



**YOKI ES111** Design by CDC/FGL

230~



**Socket/Bulb:**  
GU10/ES111 (excl.)  
75W max.

**Material:**  
Aluminium

**Dimensions:**  
L/W/H: 8,5/5/25,5 cm

**Accessory/Included parts:**  
Easytec® II-adapter (incl.)  
Deco ring (incl.)

**Note:**  
Without deco ring suitable for  
DomeLED ES111 bulb.

**Versions:**  
silver grey

**Art. No.:**  
184624

**Recommended bulb:**  
75W, 24°, 2700K, 2000cd  
575672

**BLOX**

230~



**Socket/Bulb:**  
GU10/GU10 (excl.)  
50W max.

**Material:**  
Aluminium/glass

**Dimensions:**  
L/W/H: 19,5/5,5/11 cm

**Accessory/Included parts:**  
Easytec® II-adapter (incl.)

**Versions:**  
silver grey

**Art. No.:**  
184542

**Recommended bulb:**  
35W EnergySaver ≈ 50W  
20°, 2800K, 1200cd  
575370

**ANILA**

230~



**Socket/Bulb:**  
GU10/GU10 (excl.)  
50W max.

**Material:**  
Aluminium/glass

**Dimensions:**  
Ø/L: 7/23,5 cm

**Accessory/Included parts:**  
Easytec® II-adapter (incl.)

**Versions:**  
silver grey

**Art. No.:**  
184634

**Recommended bulb:**  
35W EnergySaver ≈ 50W  
20°, 2800K, 1200cd  
575370

**KANO**

230~



**Socket/Bulb:**  
GU10/GU10 (excl.)  
50W max.

**Material:**  
Aluminium/glass

**Dimensions:**  
Ø/L: 6,5/18 cm

**Accessory/Included parts:**  
Easytec® II-adapter (incl.)

**Versions:**  
silver grey

**Art. No.:**  
184071

**Recommended bulb:**  
35W EnergySaver ≈ 50W  
20°, 2800K, 1200cd  
575370

**ANABA**

230~



**Socket/Bulb:**  
GU10/GU10 (excl.)  
50W max.

**Material:**  
Aluminium/ceramic

**Dimensions:**  
Ø/L: 6,3/24 cm

**Accessory/Included parts:**  
Easytec® II-adapter (incl.)

**Versions:**  
silver grey/white ▼

**Art. No.:**  
184651

**Recommended bulb:**  
35W EnergySaver ≈ 50W  
20°, 2800K, 1200cd  
575370





## YANTI

230~



**Socket/Bulb:**  
G9/G9 (excl.)  
40W max.

**Material:**  
Aluminium/ceramic

**Dimensions:**  
Ø/L: 7/20 cm

**Accessory/Included parts:**  
Easytec® II-adaptor (incl.)

**Versions:**  
silver grey/white

**Art. No.:**  
184152

**Recommended bulb:**  
33W EnergySaver ≙ 40W  
2700K, 460lm, EEK=C  
519451



## SWIFTEC Design by CDC/FGL

230~



**Socket/Bulb:**  
G9/G9 (excl.)  
40W max.

**Material:**  
Aluminium/glass

**Dimensions:**  
Ø/L: 6/21 cm

**Accessory/Included parts:**  
Easytec® II-adaptor (incl.)

**Versions:**  
silver grey  
Glass satined

**Art. No.:**  
184282

**Recommended bulb:**  
33W EnergySaver ≙ 40W  
2700K, 460lm, EEK=C  
519451



## SWIFTEC PENDANT

230~



**Socket/Bulb:**  
G9/G9 (excl.)  
40W max.

**Material:**  
Glass

**Dimensions:**  
Glass-Ø/H: 6/10 cm

**Accessory/Included parts:**  
Easytec® II-pendant lamp  
adaptor (incl.)

**Versions:**  
Glass satined

**Art. No.:**  
184372

**Recommended bulb:**  
33W EnergySaver ≙ 40W  
2700K, 460lm, EEK=C  
519451



## NEPRO R7s

230~



Series: page 158, 288



**Socket/Bulb:**  
R7s/R7s, 118 mm (excl.)  
300W max.

**Material:**  
Aluminium

**Dimensions:**  
L/W/H: 17,5/11/19,5 cm

**Accessory/Included parts:**  
Easytec® II-adaptor (incl.)

**Versions:**  
silver grey

**Art. No.:**  
184552

**Recommended bulb:**  
200W EnergySaver ≙ 300W  
2700K, 4000lm, EEK=C  
519223



## SAIL R7s Design by CDC/FGL

230~

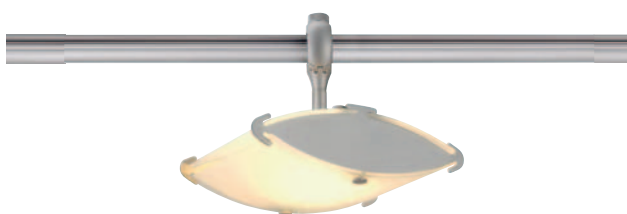

**Socket/Bulb:**  
R7s/R7s, 78 mm (excl.)  
100W max.

**Material:**  
Steel/glass satined

**Dimensions:**  
L/W/H: 20/15/16,5 cm

**Accessory/Included parts:**  
Easytec® II-adaptor (incl.)

**Versions:**  
silver grey

**Art. No.:**  
184572

**Recommended bulb:**  
100W EnergySaver ≙ 150W  
2700K, 1900lm, EEK=C  
519215



**LIGHT EYE PENDANT**

230~ 1,5m 07

**Socket/Bulb:**  
 GU10/ES111 (excl.)  
 75W max.

**Material:**  
 Steel  
 Black textile-coated cable

**Dimensions:**  
 Head-Ø/H: 14,5/14,5 cm

**Accessory/Included parts:**  
 Easytec® II-pendant lamp  
 adapter (incl.)

**Versions:**  
 chrome

**Art. No.:**  
 184592

**Recommended bulb:**  
 75W, 24°, 2700K, 2000cd  
 575672

**PIRUS**

230~ 1,5m 053

**Socket/Bulb:**  
 E14/AGL candle shape (excl.)  
 40W max.  
 or  
 E14/EnergySaver (excl.)  
 up to max. Ø/L: 3,8/11,7 cm

**Material:**  
 Steel/glass  
 Red textile-coated Cable

**Dimensions:**  
 Head-Ø/H: 14/19 cm

**Accessory/Included parts:**  
 Easytec® II-pendant lamp  
 adapter (incl.)

**Versions:**  
 chrome

**Art. No.:**  
 184221

**Recommended bulb:**  
 11W, 2700K, 530lm, EEK=A  
 508810



## BIBA 3

230~



1,5m



**Socket/Bulb:**  
E14/AGL (excl.)  
60W max.  
or  
E14/EnergySaver (excl.)  
up to max. Ø/H: 5/13 cm

**Material:**  
Glass

**Dimensions:**  
Glass-Ø/H: 13/26 cm

**Accessory/Included parts:**  
Easytec® II-pendant lamp  
adapter (incl.)

**Versions:**  
silver grey/glass satined

**Art. No.:**  
184521

**Recommended bulb:**  
11W, 2700K, 530lm, EEK=A  
508810



## TONGA 1/4

230~



1,5m

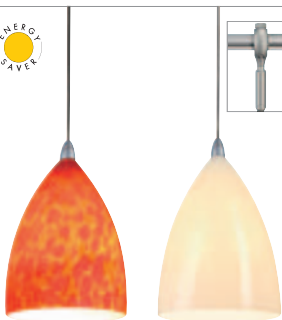

**Socket/Bulb:**  
E14/AGL (excl.)  
60W max.  
or  
E14/EnergySaver (excl.)  
up to max. Ø/H: 5/13 cm

**Material:**  
Tonga 1 glass  
Tonga 4 ceramic

**Dimensions:**  
Glass-Ø/H: 15/22 cm

**Accessory/Included parts:**  
Easytec® II-pendant lamp  
adapter (incl.)

**Note:**  
The illustrated lamp shade of the  
Tonga 1 is made of coloured  
mouth-blown glass. Every lamp is  
an unique whereby the marbling  
can vary.

**Versions:**  
**Tonga 1**  
Glass red/orange  
**Tonga 4**  
Ceramic white

**Art. No.:**  
184531  
184534

**Recommended bulb:**  
11W, 2700K, 530lm, EEK=A  
508810



1

4

**ACCESSORY for Easytec® II, silver grey**

	<p><b>Track</b> silver grey/1 pce. Aluminium L/W/H: 200/1/3 cm 2 silver grey end caps (incl.)</p> <p>Art. No.: 184022</p>		<p><b>Feed-in</b> silver grey/1 pce. Aluminium/glass L/W/H: 7,5/7,5/6 cm Cable-L: 40 cm</p> <p>Art. No.: 184002</p>
	<p><b>Ceiling suspension 10 cm</b> silver grey/1 pce. L: 10 cm</p> <p>Art. No.: 184042</p>		<p><b>Ceiling suspension, flexible</b> silver grey/1 pce. L: adjustable 18-26 cm</p> <p>Art. No.: 184062</p>
	<p><b>Flexible suspension bracket</b> silver grey/1 pce. For slanted ceilings. Joint: 180° Total-L: 23-31 cm</p> <p>Art. No.: 184332</p>		<p><b>Flexible wall bracket with guy rope</b> silver grey/1 pce. L/W/H: 27/2,5/7 cm Adjustable from 15,5-24 cm Rope length: 40 cm</p> <p>Art. No.: 184312</p>
	<p><b>Longitudinal coupler</b> silver grey/1 pce.</p> <p>Art. No.: 184032</p>		<p><b>Insulating coupler</b> silver grey/1 pce.</p> <p>Art. No.: 184172</p> <p>For the use of 2 separate circuits.</p>
	<p><b>Flexible coupler</b> silver grey/1 pce. L/W/H: 21,5/3/4 cm</p> <p>Art. No.: 184302</p>		<p><b>Pendant lamp adapter</b> silver grey/1 pce. Load: 0,7 kg max. Product-L: 13 cm Easy shortening of the pendant length. Only for lamps with protection class 2.</p> <p>Art. No.: 184292</p>
	<p><b>End caps</b> silver grey/2 pce.</p> <p>Art. No.: 184142</p>		<p><b>Bending machine</b> for radius-Ø: &gt; 50 cm</p> <p>Art. No.: 184000</p>

# LINUX LIGHT® CHROME

Spotlight for  
Linux Light®  
chrome/black

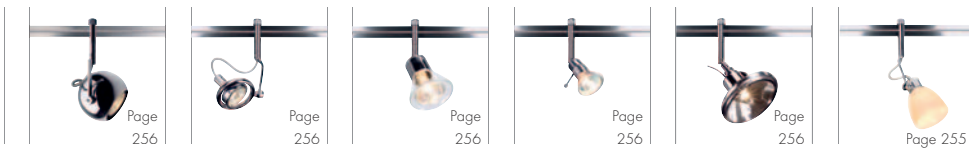

Pendant luminaires  
for Linux Light®  
chrome/black



# LINUX LIGHT® SILVER GREY

Spotlight for  
Linux Light®  
silver grey



Pendant luminaires  
for Linux Light®  
silver grey



**NONDRI**

12~



**Socket/Bulb:**  
G6,35/pin socket (excl.)  
50W max.

**Material:**  
Aluminium/ceramic

**Dimensions:**  
Ø/L: 7,5/22 cm

**Accessory/Included parts:**  
Linux Light<sup>®</sup>-adapter (incl.)

**Versions:**  
chrome/white

**Art. No.:**  
136072

**Recommended bulb:**  
50W, 2700K, 900lm  
512250

**ORION PENDANT**

12~



**Socket/Bulb:**  
GY6,35/pin socket (excl.)  
50W max.

**Material:**  
Glass

**Dimensions:**  
Shade-Ø/H: 12,5/9 cm

**Accessory/Included parts:**  
Linux Light<sup>®</sup>-pendant lamp  
adapter (incl.)

**Versions:**  
chrome/white satined

**Art. No.:**  
136201

**Recommended bulb:**  
50W, 2700K, 900lm  
512250

**DEWI**

12~



**Socket/Bulb:**  
GY6,35/pin socket (excl.)  
50W max.

**Material:**  
Ceramic

**Dimensions:**  
Shade-Ø/H: 9/10,5 cm

**Accessory/Included parts:**  
Linux Light<sup>®</sup>-pendant lamp  
adapter (incl.)

**Versions:**  
chrome/white

**Art. No.:**  
136375

**Recommended bulb:**  
50W, 2700K, 900lm  
512250







## LIGHT EYE SPOT MR16

12~



**Socket/Bulb:**  
GU5,3/MR16 (excl.)  
50W max.

**Material:**  
Steel

**Dimensions:**  
W/H: 10/18,5 cm  
Head-Ø: 9 cm

**Accessory/Included parts:**  
Linux Light<sup>®</sup>-adapter (incl.)

**Versions:**  
chrome

**Art. No.:**  
136184

**Recommended bulb:**  
50W, 2700K  
535527, 25°, 2450cd  
535540, 40°, 1500cd



## LIKA Design by CDC

12~



**Socket/Bulb:**  
GX5,3/MR16 (excl.)  
50W max.

**Material:**  
Aluminium

**Dimensions:**  
Ø/L: 8/15 cm

**Accessory/Included parts:**  
Linux Light<sup>®</sup>-adapter (incl.)

**Versions:**  
chrome

**Art. No.:**  
136372

**Recommended bulb:**  
50W, 2700K  
535527, 25°, 2450cd  
535540, 40°, 1500cd



## ANILA

12~



**Socket/Bulb:**  
GU5,3/MR16 (excl.)  
50W max.

**Material:**  
Aluminium/glass

**Dimensions:**  
Ø/L: 7/21 cm

**Accessory/Included parts:**  
Linux Light<sup>®</sup>-adapter (incl.)

**Versions:**  
chrome

**Art. No.:**  
136174

**Recommended bulb:**  
50W, 2700K  
535527, 25°, 2450cd  
535540, 40°, 1500cd



## SYROS

12~



**Socket/Bulb:**  
GU5,3/MR16 (excl.)  
50W max.

**Material:**  
Aluminium

**Dimensions:**  
Ø/L: 5,5/15 cm

**Accessory/Included parts:**  
Linux Light<sup>®</sup>-adapter (incl.)

**Versions:**  
chrome

**Art. No.:**  
136212

**Recommended bulb:**  
50W, 2700K  
535527, 25°, 2450cd  
535540, 40°, 1500cd



## QRB SPOT

12~



**Socket/Bulb:**  
G53/QRB111 (excl.)  
50W max.

**Material:**  
Aluminium

**Dimensions:**  
Ø/L: 6/16,5 cm

**Accessory/Included parts:**  
Linux Light<sup>®</sup>-adapter (incl.)













**Versions:**  
chrome

**Art. No.:**  
136342

**Recommended bulb:**  
50W EnergySaver  $\approx$  75W  
545752, 24°, 3000K, 5800cd  
545753, 40°, 3000K, 2000cd

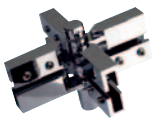
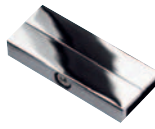

**ACCESSORY for Linux Light® chrome**

 <p>12~ 25A max.</p>	 <p><b>Track</b> chrome/1 pce. Aluminium 2 clear end caps (incl.) L/W/H: 200/2,3/0,5 cm Bending machine (138200) page 263</p> <p>Art. No.: 136222</p>		<p><b>Feed-in, 25A max.</b> chrome/1 pce. Ø/H: 3,7/2,9 cm Cable-L: 60 cm</p> <p>Art. No.: 136252</p>
 <p>230~ 12~ 20-105 VA</p>	 <p><b>Shortbox Transf., 20-105VA</b> Art. No.: 136192 chrome/1 pce. Plastic L/W/H: 18/5/10 cm Max. track length: 2 m Open circuit voltage: 11,5V ta: 50°C, tc: 70°C Electronic transformer (incl.) In case of a laterally protruding of &gt;75 cm, the ceiling suspension 10 cm (136246) is needed. Further transformers see page 596-599.</p>		<p><b>Ceiling suspension, 6,5 cm</b> Art. No.: 136240 chrome/1 pce. Aluminium</p>
			<p><b>Ceiling suspension, 10 cm</b> Art. No.: 136246 chrome/1 pce. Aluminium</p> <p>Is suitable for Linux Light® Shortbox transformer (136192).</p>
	<p><b>Flexible coupler L, 25A max.</b> Art. No.: 136402 chrome/1 pce. Swivel range: 240° Weight: 0,06 kg</p>		<p><b>Ceiling suspension, flexible</b> Art. No.: 136260 chrome/1 pce. Aluminium Product-L: 17,5-26 cm</p>
	<p><b>Flexible coupler Y, 25A max.</b> Art. No.: 136412 chrome/1 pce. Swivel range: &lt;45° Weight: 0,17 kg</p>		<p><b>Longitudinal coupler, 25A max.</b> Art. No.: 136202 chrome/1 pce.</p>
	<p><b>Flexible coupler X, 25A max.</b> Art. No.: 136422 chrome/1 pce. Swivel range: &lt;60° Weight: 0,21 kg</p>		<p><b>Insulating coupler</b> Art. No.: 136232 chrome/1 pce.</p> <p>For the use of 2 separate circuits.</p>
	<p><b>Rope suspension</b> Art. No.: 136250 chrome/1 pce. Pendant-L: 2,5 m</p>		<p><b>End caps</b> Art. No.: 138380 clear/2 pce. Plastic</p>



**LIGHT EYE SPOT MR16**

12~



**Socket/Bulb:**  
GU5,3/MR16 (excl.)  
50W max.

**Material:**  
Steel

**Dimensions:**  
W/H: 10/18,5 cm  
Head-Ø: 9 cm

**Accessory/Included parts:**  
Linux Light<sup>®</sup>-adapter (incl.)

**Versions:**  
silver grey

**Art. No.:**  
138184

**Recommended bulb:**  
50W, 2700K  
535527, 25°, 2450cd  
535540, 40°, 1500cd

**Q-TECH<sup>®</sup> SPOT MR16**

12~



**Socket/Bulb:**  
G5,3/MR16 (excl.)  
50W max.

**Material:**  
Aluminium

**Dimensions:**  
L/WØ: 22,5/8/6 cm

**Accessory/Included parts:**  
Linux Light<sup>®</sup>-adapter (incl.)

**Versions:**  
silver grey ▼

**Art. No.:**  
138544

**Recommended bulb:**  
50W, 40°, 2700K, 1500cd  
536540

**LIKA** Design by CDC

12~



**Socket/Bulb:**  
GX5,3/MR16 (excl.)  
50W max.

**Material:**  
Aluminium

**Dimensions:**  
Ø/L: 8/15 cm

**Accessory/Included parts:**  
Linux Light<sup>®</sup>-adapter (incl.)

**Versions:**  
silver grey

**Art. No.:**  
138372

**Recommended bulb:**  
50W, 2700K  
535527, 25°, 2450cd  
535540, 40°, 1500cd

**SPACE**

12~

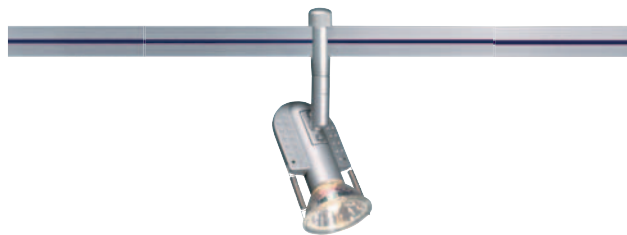

**Socket/Bulb:**  
G5,3/MR16 (excl.)  
50W max.

**Material:**  
Aluminium

**Dimensions:**  
L/W/H: 7,3/5/16,5 cm

**Accessory/Included parts:**  
Linux Light<sup>®</sup>-adapter (incl.)

**Versions:**  
silver grey

**Art. No.:**  
138322

**Recommended bulb:**  
50W, 2700K  
535527, 25°, 2450cd  
535540, 40°, 1500cd

**QRB SPOT**

12~

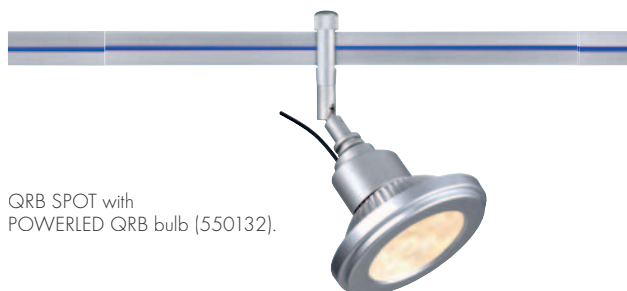

**Socket/Bulb:**  
G53/QRB111 (excl.)  
50W max.

**Material:**  
Aluminium

**Dimensions:**  
Ø/L: 6/16,5 cm

**Accessory/Included parts:**  
Linux Light<sup>®</sup>-adapter (incl.)

**Versions:**  
silver grey

**Art. No.:**  
138342

**Recommended bulb:**  
50W EnergySaver ≈ 75W  
545752, 24°, 3000K, 5800cd  
545753, 40°, 3000K, 2000cd



QRB SPOT with  
POWERLED QRB bulb (550132).



## SYROS

12~



**Socket/Bulb:**  
GX5,3/MR16 (excl.)  
50W max.

**Material:**  
Aluminium

**Dimensions:**  
Ø/L: 5,5/15 cm

**Accessory/Included parts:**  
Linux Light<sup>®</sup>-adapter (incl.)

**Versions:**  
silver grey

**Art. No.:**  
138212

**Recommended bulb:**  
50W, 2700K  
535527, 25°, 2450cd  
535540, 40°, 1500cd



## ANILA

12~



**Socket/Bulb:**  
GU5,3/MR16 (excl.)  
50W max.

**Material:**  
Aluminium/glass

**Dimensions:**  
Ø/L: 7/21 cm

**Accessory/Included parts:**  
Linux Light<sup>®</sup>-adapter (incl.)

**Versions:**  
silver grey  
Glass clear

**Art. No.:**  
138174

**Recommended bulb:**  
50W, 2700K  
535527, 25°, 2450cd  
535540, 40°, 1500cd



## STRATOS

12~



**Socket/Bulb:**  
GU5,3/MR16 (excl.)  
50W max.

**Material:**  
Aluminium/glass

**Dimensions:**  
Ø/H: 6/15 cm

**Accessory/Included parts:**  
Linux Light<sup>®</sup>-adapter (incl.)

**Versions:**  
silver grey  
Glass satined

**Art. No.:**  
138291

**Recommended bulb:**  
50W, 2700K  
535527, 25°, 2450cd  
535540, 40°, 1500cd



## YANTI

12~

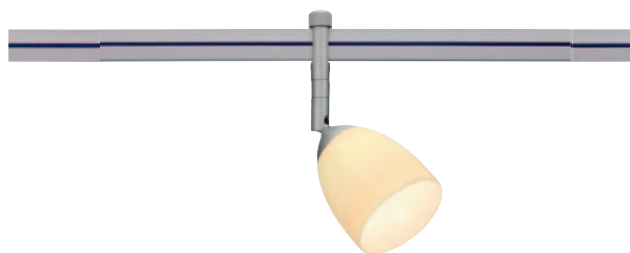

**Socket/Bulb:**  
GY6,35/pin socket (excl.)  
50W max.

**Material:**  
Aluminium/ceramic

**Dimensions:**  
Ø/L: 7/17,5 cm

**Accessory/Included parts:**  
Linux Light<sup>®</sup>-adapter (incl.)

**Versions:**  
silver grey  
white

**Art. No.:**  
138362

**Recommended bulb:**  
50W, 2700K, 900lm  
512250



## NONDRI

12~



**Socket/Bulb:**  
GY6,35/pin socket (excl.)  
50W max.

**Material:**  
Aluminium/ceramic

**Dimensions:**  
Ø/L: 7,5/22 cm

**Accessory/Included parts:**  
Linux Light<sup>®</sup>-adapter (incl.)

**Versions:**  
silver grey  
white

**Art. No.:**  
138072

**Recommended bulb:**  
50W, 2700K, 900lm  
512250



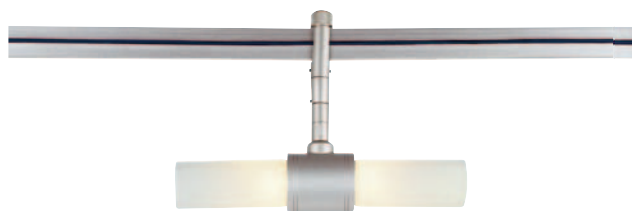

**LIGHT TUBE** Design by CDC

 12~  350°  0,17  

**Socket/Bulb:**  
G4/pin socket (excl.)  
2x 20W max.

**Material:**  
Aluminium/glass

**Dimensions:**  
Ø/W/H: 4,3/20/13 cm

**Accessory/Included parts:**  
Linux Light<sup>®</sup>-adapter (incl.)

**Versions:**  
silver grey  
Glass satinéd

**Art. No.:**  
138041

**Recommended bulb:**  
20W, 2700K, 330lm  
512220

**SAIL**

 12~  350°  0,17  

**Socket/Bulb:**  
GY6,35/pin socket (excl.)  
35W max.

**Material:**  
Aluminium/glass

**Dimensions:**  
L/W/H: 12/8/6,5 cm

**Accessory/Included parts:**  
Linux Light<sup>®</sup>-adapter (incl.)

**Versions:**  
silver grey  
Glass satinéd

**Art. No.:**  
138211

**Recommended bulb:**  
35W, 2700K, 595lm  
512235

**ORION PENDANT**

 12~  1,5m  0,45  

**Socket/Bulb:**  
GY6,35/pin socket (excl.)  
50W max.

**Material:**  
Brass/glass

**Dimensions:**  
Shade-Ø/H: 12,5/9 cm

**Accessory/Included parts:**  
Linux Light<sup>®</sup>-pendant lamp  
adapter (incl.)

**Versions:**  
silver grey  
white satinéd

**Art. No.:**  
138201

**Recommended bulb:**  
50W, 2700K, 900lm  
512250

**ORION JOJO**

 12~  3m  1,0  

**Socket/Bulb:**  
GY6,35/pin socket (excl.)  
50W max.

**Material:**  
Brass/glass

**Dimensions:**  
Shade-Ø/H: 12,5/9 cm

**Accessory/Included parts:**  
Linux Light<sup>®</sup>-pendant lamp  
adapter (incl.)

**Versions:**  
silver grey  
white satinéd

**Art. No.:**  
138231

**Recommended bulb:**  
50W, 2700K, 900lm  
512250

**TONGA 4**

 12~  1,5m  1,07  

**Socket/Bulb:**  
GY6,35/pin socket (excl.)  
50W max.

**Material:**  
Brass/ceramic

**Dimensions:**  
Shade-Ø/H: 15/22 cm

**Accessory/Included parts:**  
Linux Light<sup>®</sup>-pendant lamp  
adapter (incl.)

**Versions:**  
Tonga 4, white

**Art. No.:**  
138144

**Recommended bulb:**  
50W, 2700K, 900lm  
512250

**ACCESSORY for Linux Light® silver grey**

 <p>12~ 25A max.</p>	<p>   <b>Track</b>                      silver grey/1 pce. 1 m Art. No.: 138221                      Aluminium                      W/H: 2,3/0,5 cm 2 m 138222                      2 silver grey end caps (incl.)                 </p>		<p><b>Feed-in, 25A max.</b>                      silver grey/1 pce.                      Ø/H: 3,7/2,9 cm                      Cable-L: 60 cm</p> <p>Art. No.: 138252</p>
 <p>230~ 12~ 20-105 VA</p>	<p>   <b>Shortbox Transf., 20-105VA</b> Art. No.: 138192                      silver grey/1 pce.                      Plastic                      L/W/H: 18/5/10 cm                      Max. track length: 2 m                      Open circuit voltage: 11,5V                      ta: 50°C, tc: 70°C                      Electronic transformer (incl.)                      In case of a laterally protruding of &gt;75 cm, the ceiling suspension 10 cm (138246) is needed.                      Further transformers see page 596-599.                 </p>		<p><b>Ceiling suspension, 6,5 cm</b> Art. No.: 138240                      silver grey/1 pce.                      Aluminium</p>
			<p><b>Ceiling suspension, 10 cm</b> Art. No.: 138246                      silver grey/1 pce.                      Aluminium</p> <p>Is suitable for Linux Light® Shortbox transf. (136192).</p>
	<p><b>Flexible coupler L, 25A max.</b> Art. No.: 138402                      silver grey/1 pce.                      Swivel range: 240°                      Weight: 0,06 kg</p>		<p><b>Ceiling suspension, 21 cm</b> Art. No.: 138262                      silver grey/1 pce.                      Aluminium</p>
	<p><b>Flexible coupler Y, 25A max.</b> Art. No.: 138412                      silver grey/1 pce.                      Swivel range: &lt;45°                      Weight: 0,17 kg</p>		<p><b>Ceiling suspension, flexible</b> Art. No.: 138260                      silver grey/1 pce.                      Aluminium                      Product-L: 17,5-26 cm</p>
	<p><b>Flexible coupler X, 25A max.</b> Art. No.: 138422                      silver grey/1 pce.                      Swivel range: &lt;60°                      Weight: 0,21 kg</p>		<p><b>Longitudinal coupler, 25A max.</b> Art. No.: 138202                      silver grey/1 pce.</p>
	<p><b>Ceiling suspension for slanted ceilings, flexible</b> Art. No.: 138432                      silver grey/1 pce.                      Aluminium                      Joint: 180°                      Product-L: 20-30 cm</p>		<p><b>Insulating coupler</b> Art. No.: 138232                      silver grey/1 pce.</p> <p>For the use of 2 separate circuits.</p>
	<p><b>Wall bracket, flexible</b> Art. No.: 138270                      silver grey/1 pce.                      Aluminium.                      Product-L: 12,5-21 cm</p>		<p><b>End caps</b> Art. No.: 138280                      silver grey/2 pce.                      Plastic</p>
	<p><b>Rope suspension</b> Art. No.: 138250                      silver grey/1 pce.                      Pendant-L: 2,5 m</p>		<p><b>Pendant lamp adapter</b> Art. No.: 138522                      silver grey/1 pce.                      Aluminium                      Product-L: 13 cm</p>
	<p><b>Bending machine</b> Art. No.: 138200                      1 pce.                      for radius-Ø: &gt; 40 cm</p>		



# C-TRACK®



Here are some possible areas of application:

- Showcase interior lighting
- Mirror lighting
- Indirect lighting
- Illuminated picture holder track

The space-saving 12 volt track-system.

With the available modules, the user can very easily configure and assemble the C-Track®. In short time presentation areas and illuminations are installed in one process. The low voltage technology is up to date and with the usage of normal 12 volt output current completely safe.

Even in the narrowest areas a specific illumination is possible. With a rotation of 90° the C-Track® spotlights can simply be clipped into any desirable place of the shelf track. Three types of spotlights are available for the individual light arrangement.

## KARDANIC SPOT C-Track®

12~     



**Socket/Bulb:**  
G5,3/MR16 (excl.)  
35W max.

**Material:**  
Aluminium/Steel

**Dimensions:**  
L/W/H: 6,5/3,3/3,3 cm

**Versions:**  
silver grey

**Art. No.:**  
188142

**Recommended bulb:**  
35W, 40°, 2700K, 810cd  
535338



## DABO SPOT C-Track®

12~     



**Socket/Bulb:**  
G5,3/MR16 (excl.)  
35W max.

**Material:**  
Aluminium

**Dimensions:**  
L/W/H: 7/2,3/7 cm

**Versions:**  
silver grey

**Art. No.:**  
188152

**Recommended bulb:**  
35W, 40°, 2700K, 810cd  
535338



## GOOSE SPOT C-Track®

12~   



**Socket/Bulb:**  
G4/MR11 (excl.)  
35W max.

**Material:**  
Steel

**Dimensions:**  
L/W/H: 23,5/2,3/2,3 cm

**Versions:**  
silver grey

**Art. No.:**  
188122

**Recommended bulb:**  
35W, 30°, 2700K, 720cd  
533330





## ACCESSORY for C-Track®

	<p>12- 20A max.</p> <p><b>Track, 20A max.</b> silver grey Aluminium L/W/H: 200/2,3/1 cm 2 end caps (incl.)</p> <p>Art. No.: 188022</p>		<p><b>Feed-in, 20A max.</b> silver grey/1 pce. L/W/H: 5,6/2,6/1,5 cm</p> <p>Art. No.: 188002</p>
	<p><b>Longitudinal coupler, 20A max.</b> silver grey/1 pce. L/W/H: 4,3/2,3/1 cm</p> <p>Art. No.: 188162</p>		<p><b>Flexible coupler, 20A max.</b> silver grey/1 pce. L/W/H: 19/2,5/1,5 cm</p> <p>Art. No.: 188182</p>
	<p><b>Coupler side, 20A max.</b> silver grey/2 pce. L/W/H: 3,3/3,3/1 cm</p> <p>Art. No.: 188042</p>		<p><b>Rope shelf bracket</b> silver grey/2 pce. Aluminium Rope-L: 1,2 m</p> <p>Art. No.: 188112</p> <p>For fastening of shelves up to 30 cm width and max. 6 mm thickness. Mechanical load per rope: 12 kg.</p>
	<p><b>Wall and ceiling bracket</b> silver grey/4 pce. W/H/D: 0,9/1,7/0,9 cm</p> <p>Art. No.: 188062</p>		<p><b>End caps</b> silver grey/2 pce. L/W/H: 2/2,3/1 cm</p> <p>Art. No.: 188032</p>

# GLU-TRAX®

## ROBOT 2 slewable, for GLU-TRAX®

12~    



**Socket/Bulb:**  
G5,3/MR16 (excl.)  
35W max.

**Material:**  
Steel/plastic

**Dimensions (without bulb):**  
W/H/D: 3/3/2,2 cm





**Versions:**  
chrome

**Art. No.:**  
186762

**Recommended bulb:**  
35W, 40°, 2700K, 810cd  
535338



## SOLO 90° slewable, for GLU-TRAX®

12~     



**Socket/Bulb:**  
G5,3/MR16 (excl.)  
50W max.

**Material:**  
Brass

**Dimensions:**  
Head-Ø/H: 2,2/3 cm







**Versions:**  
chrome

**Art. No.:**  
186272

**Recommended bulb:**  
50W, 40°, 2700K, 1500cd  
535540



## FOCU-LED SPOT for GLU-TRAX®

12~       

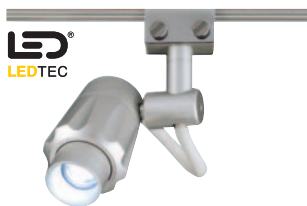

**Accessory/Included parts:**  
LED converter (incl.)

**Note:**  
Focusable with an angle of radiation  
of 15°-30°  
Operate only with conventional  
transformer!

**Bulb:**  
PowerLED (incl.)  
1W





**Material:**  
Aluminium

**Dimensions:**  
Ø/H: 3,4/5,8 cm

**Versions:**  
silver grey  
LED white ▼

**Art. No.:**  
186282

## POWER-LED SPOT for GLU-TRAX®

12~       



**Accessory/Included parts:**  
LED converter (incl.)

**Note:**  
Operate only with conventional  
transformer!

**Bulb:**  
PowerLED (incl.)  
1W

**Material:**  
Aluminium/PC

**Dimensions:**  
Ø/H: 2,7/6,35 cm

**Versions:**  
silver grey  
LED white  
LED warm white

**Art. No.:**  
186041  
186042

## ACCESSORY for GLU-TRAX®



12~ 20A max.

**Track, 20A max.**  
transparent  
Plastic PC  
L/W/H: 150/1/0,5 cm  
**Art. No.:**  
186015

Laying e.g. with **double-sided adhesive tape**, 3 m **220000**



**Mounting clips**  
clear, 10 pce.  
Plastic PC  
Ø/H: 1,7/0,8 cm

Max. distance of clips: 50 cm.  
Max. mechanical load: 1 kg.

**Art. No.:**  
186020

The clips are equipped with a adhesive surface for mounting on smooth surfaces as well as with a bore hole for screw joints. We recommend the fixation with a screw for wood.



**Longitudinal coupler, flexible, 20A max.**  
grey/1 pce.  
L/W/H: 7,3/1,4/0,8 cm

**Art. No.:**  
186772



**Feed-in/Longitudinal coupler, 20A max.**  
grey/1 pce.

**Art. No.:**  
186952







# MINI ALU TRACK

## LED SPOT for Mini Alu-Track

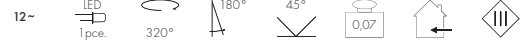

Accessory/Included parts:  
LED converter (incl.)

Bulb:  
PowerLED (incl.)  
1W

Material:  
Aluminium/PC

Dimensions:  
Ø/H: 2,3/4,5 cm

Versions:  
chrome  
LED white  
LED warm white

Art. No.:  
186561  
186562

## ACCESSORY for Mini Alu-Track



12~



Mini Alu-Track  
12,5A max.  
chrome  
Aluminium/PC  
L/W/H: 100/1,1/0,85 cm  
2 end caps, clear (incl.)

Art. No.:  
186502

Operate only with conventional  
transformer.



Suspension  
chrome/1 pce. 5 cm Art. No.: 186531  
Steel/brass

10 cm Art. No.: 186532

25 cm Art. No.: 186533

A wall mounting is only possible with  
the 5 cm suspension!



Feed-in, 12,5A max.  
chrome/1 pce.  
L/W/H: 1,4/2,2/1,7 cm

Art. No.:  
186512



Longitudinal coupler,  
12,5A max.  
chrome/1 pce.  
L/W/H: 1,8/1,1/0,8 cm

Art. No.:  
186522

For the electrical connection of the  
tracks (186502).

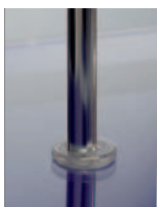

Feed-through  
for shelves  
clear/2 pce.  
Acrylic  
Ø/H: 2,2/1,3 cm

Art. No.:  
186540



Mounting clips  
clear, 10 pce.  
Plastic PC  
L/W/H: 2,5/1,5/1,1 cm

Art. No.:  
186530

Track bracket with adhesive pad for  
mounting the track on glass surfaces  
and with a bore for screw mounting.



# CABLINE

Decorative accent lighting is installed in no time at all:

- Long operating life of approximately 10.000 hours through Xenon and LED technology.
- Optional accessories: mounting track + diffuser cap
- Quick fastening through simply clipping on the bulb holders
- Flexible lead
- Straight laying

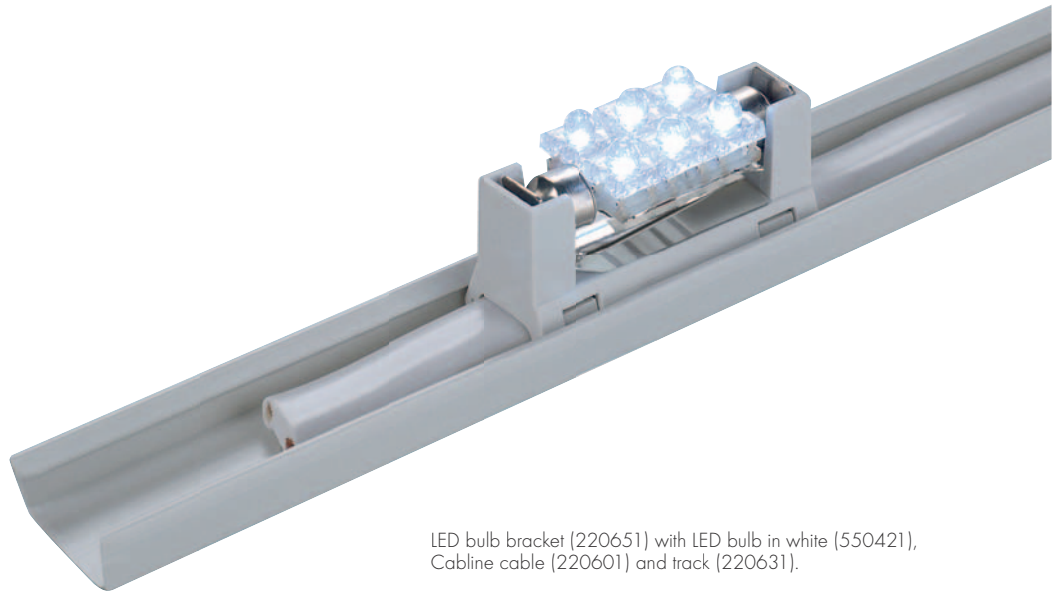

LED bulb bracket (220651) with LED bulb in white (550421), Cabline cable (220601) and track (220631).

## XENON BULB 2800K, 10 pce.

12~



Article No.	Description	Wattage	Ø in cm	Length in cm				
591230 ▼	Xenon-LM, clear	10W	1,0	4,2	100lm	2800K	EEL-C	

## LED BULB

12~



Article No.	Description	Socket	Wattage	Length in cm	LED colour		
550421 ▼	Superflux LED	SV8,58	0,52W	4,2	white	10lm	
550422 ▼	Superflux LED	SV8,58	0,52W	4,2	warm white	10lm	

Operate only with conventional transformer! Please pay attention to the minimum load of the transformer!

## ACCESSORY for Cabline

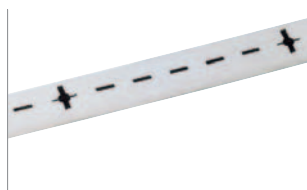

12~



Cable, 16A max.  
white ▼  
Cable-L: 10 m  
W/H: 1,1/0,45 cm

Art. No.:  
220601



Laying track  
white  
L/W/H: 100/2/0,9 cm

Art. No.:  
220631

Wire cross-section: 2,5 mm<sup>2</sup>



Xenon bulb holder  
white/10 pce. ▼  
Plastic PC  
L/W/H: 4,5/2,3/1,8 cm

Art. No.:  
220611

For 12V Xenon bulbs see above.



LED bulb holder  
white/10 pce. ▼  
Plastic PC  
L/W/H: 5/1,8/2,5 cm

Art. No.:  
220651

Only for LED bulb see above.

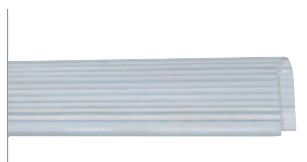

Track cover  
clear ▼  
L/W/H: 100/2,3/3,5 cm

Art. No.:  
220641



End caps  
white/2 pce. ▼

Art. No.:  
220621



# APOLLO

## SLEWABLE LAMP HOLDER for Apollo NV-Track

12~



**Socket/Bulb:**  
GX5,3/ MR16; pin socket (excl.)  
35W max.

**Versions:**  
black/2 pce.  
white/2 pce.  
silver grey/2 pce.

**Art. No.:**  
180080  
180081  
180082

**Recommended bulb:**  
35W, 40°, 2700K, 810cd  
535338



## ACCESSORY for Apollo low-voltage track

230~  
12~50-150  
VA

**Electronic track transformer** Art. No.:  
Plastic black 182150  
white 182151  
silver grey 182152

L/W/H: 18,4/4,4/4,5 cm

Due to electromagnetic interferences, the maximum length of electronic transformers may not exceed 2m!  
When using the wall brackets (180160/-1) a feed-in (180060/-1/-2) is needed to operate the Apollo transformers (182150/-1/-2)!  
Further transformers see page 596-599.

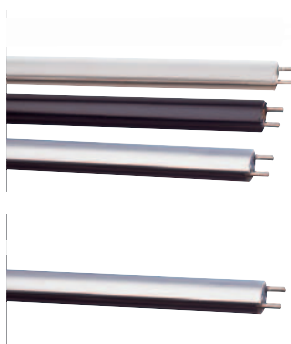

12~



**Track, 1 m, 25A max.** Art. No.:  
Aluminium black 180000  
2 pce. white 180001  
alu satin 180002

W/H: 1,6/1,2 cm

**Track, 2 m, 25A max.** Art. No.:  
Aluminium alu satin 180012  
1 pce.

W/H: 1,6/1,2 cm

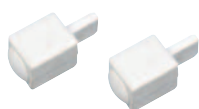

**End caps** Art. No.:  
Plastic black 180050  
2 pce. white 180051  
L/W/H: silver grey 180052  
3,6/1,6/1,8 cm



**Flexible coupler, 25A** Art. No.:  
1 pce. black 180030  
L/W/H: white 180031  
14,5/2/1,8 cm



**Longitudinal coupler, 25A** Art. No.:  
black 180040  
2 pce. white 180041  
L/W/H: silver grey 180042  
5,3/2/1,8 cm



**Feed-in, 25A** Art. No.:  
1 pce. black 180060  
L/W/H: white 180061  
11/2/1,8 cm silver grey 180062  
Cable-L: 60 cm



**Wall bracket** Art. No.:  
Plastic black 180160  
4 pce. white 180161

When using the wall brackets (180160/-1) a feed-in (180060/-1/-2) is needed to operate the Apollo transformers (182150/-1/-2)!





# WAVE

The following illustrated lamps of the Wave track systems are always equipped with a wave adapter.

## STAR for Wave

12~



**Socket/Bulb:**  
G5,3/MR16 (excl.)  
50W max.

**Material:**  
Aluminium/glass

**Dimensions:**  
L/W/H: 12,5/6/13 cm

**Versions:**  
chrome/white  
Glass satined

**Art. No.:**  
138881

**Recommended bulb:**  
50W, 2700K  
535527, 25°, 2450cd  
535540, 40°, 1500cd



## SPACE for Wave

12~



**Socket/Bulb:**  
G5,3/MR16 (excl.)  
50W max.

**Material:**  
Aluminium

**Dimensions:**  
L/W/H: 12/8/6,5 cm

**Versions:**  
Adapter silver grey  
Spot chrome

**Art. No.:**  
138832

**Recommended bulb:**  
50W, 2700K  
535527, 25°, 2450cd  
535540, 40°, 1500cd



## SYROS for Wave

12~



**Socket/Bulb:**  
G5,3/MR16 (excl.)  
50W max.

**Material:**  
Aluminium

**Dimensions:**  
L/H: 74/13 cm

**Versions:**  
chrome

**Art. No.:**  
138842

**Recommended bulb:**  
50W, 2700K  
535527, 25°, 2450cd  
535540, 40°, 1500cd



**LIGHT TUBE for Wave** Design by CDC

12~ 350° 0,25

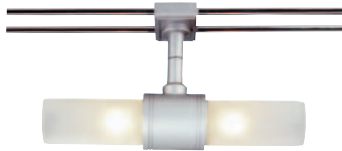
**Socket/Bulb:**  
 G4/pin socket (excl.)  
 2x 20W max.

**Material:**  
 Glass/aluminium

**Dimensions:**  
 Ø/L/H: 4,2/20/10,5 cm

**Versions:**  
 silver grey  
 Glass satinéd

**Art. No.:**  
 138848

**Recommended bulb:**  
 20W, 2700K, 330lm  
 512220

**QRB SPOT for Wave**

12~ 350° 90° 0,15

**Socket/Bulb:**  
 G53/QRB111 (excl.)  
 50W max.

**Material:**  
 Aluminium

**Dimensions:**  
 L/W: 13/6 cm

**Versions:**  
 chrome

**Art. No.:**  
 138882

**Recommended bulb:**  
 50W EnergySaver ≈ 75W  
 545752, 24°, 3000K, 5800cd  
 545753, 40°, 3000K, 2000cd

**BIG SURA PENDANT for Wave**

12~ 1,6m 0,4

**Socket/Bulb:**  
 G6,35/pin socket (excl.)  
 50W max.

**Material:**  
 Ceramic/brass, chrome-plated

**Dimensions:**  
 Head-Ø/H: 9/9,5 cm

**Note:**  
 The pendant length can be shortened  
 at the adapter.

**Versions:**  
 Adapter silver grey  
 Shade white/chrome

**Art. No.:**  
 138871

**Recommended bulb:**  
 50W, 2700K, 900lm  
 512250

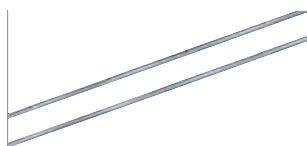
**ACCESSORY for Wave**

 12~   
**System rod, 25A max.**  
 chrome/2 rods  
 Ø/L: 0,6/70 cm  
**Art. No.:**  
 138800

**Connector**  
 chrome/10 pce.  
**Art. No.:**  
 138809

**End caps**  
 silver grey/2 pce.  
 For track width 3 cm.  
**Art. No.:**  
 138807

**Angle connector**  
 chrome/2 pce.  
**Art. No.:**  
 138803

**Cable feed-in, 25A max.**  
 chrome/2 Cable  
 Product-L: 25 cm  
**Art. No.:**  
 138808

**90°-Angle, 25A max.**  
 chrome  
 For track width 3 cm.  
 85 mm, inner  
 138804  
 115 mm, outer  
 138805

**Suspension**  
 chrome/silver grey  
 Product-L: 25 cm  
 For track width 3 cm  
 Base-Ø: 1 cm  
 Length: adjustable 16-28 cm  
**Art. No.:**  
 138806



# ROPE SYSTEM

ROPE LAMP QRB

12~



15,5



Socket/Bulb:  
G53/QRB111 (excl.)  
50W max.

Material:  
Steel

Dimensions:  
Head-Ø: 14 cm

Versions:  
chrome

Art. No.:  
186462

Recommended bulb:  
50W EnergySaver ± 75W  
545752, 24°, 3000K, 5800cd



**SAIL**

12~



15



0,15



**Socket/Bulb:**  
GY6,35/pin socket (excl.)  
35W max.

**Material:**  
Brass/glass

**Dimensions:**  
L/W/H: 12/8/9,5 cm

**Versions:**  
chrome  
Glass satined

**Art. No.:**  
181252

**Recommended bulb:**  
35W, 2700K, 595lm  
512235

**SURA**

12~



15



0,25



**Socket/Bulb:**  
GY6,35/pin socket (excl.)  
50W max.

**Material:**  
Brass/ceramic

**Dimensions:**  
Head-Ø/W/H: 6,5/16,5/12 cm

**Versions:**  
chrome  
Shade white

**Art. No.:**  
181232

**Recommended bulb:**  
50W, 2700K, 900lm  
512250

**SURA PENDANT**

12~



1,5m



0,3



**Socket/Bulb:**  
GY6,35/pin socket (excl.)  
50W max.

**Material:**  
Brass/Ceramic

**Dimensions:**  
Head-Ø/W/H: 6,5/16,5/12 cm

**Note:**  
The pendant length can be shortened  
at the adapter.

**Versions:**  
chrome  
Shade white

**Art. No.:**  
181242

**Recommended bulb:**  
50W, 2700K, 900lm  
512250

**SALUNA**

12~



10



350°



90°



0,18



**Socket/Bulb:**  
G5,3/MR16 (excl.)  
35W max.

**Material:**  
Aluminium

**Dimensions:**  
Ø/H: 5,5/12,5 cm

**Versions:**  
alu natural

**Art. No.:**  
181180

**Recommended bulb:**  
35W, 40°, 2700K, 810cd  
535338

**SYROS**

12~



15



350°



90°



0,18



**Socket/Bulb:**  
G5,3/MR16 (excl.)  
50W max.

**Material:**  
Aluminium

**Dimensions:**  
Ø/L/W: 2,5/9/17 cm

**Versions:**  
chrome

**Art. No.:**  
181212

**Recommended bulb:**  
50W, 25°, 2700K, 2450cd  
535527

**COMET**

12~



10



0,13



**Socket/Bulb:**  
GU5,3/MR16 (excl.)  
50W max.

**Material:**  
Aluminium/glass

**Dimensions:**  
Ø/H: 6/13 cm

**Versions:**  
chrome  
Glass partial satined

**Art. No.:**  
139230

**Recommended bulb:**  
50W, 25°, 2700K, 2450cd  
535527



## TELESCOPE

12~



Socket/Bulb:  
GX5,3/MR16 (excl.)  
20W max.

Dimensions:  
Rod-L: 21-52 cm

Versions:  
chrome

Art. No.:  
186492

Recommended bulb:  
20W, 40°, 2700K, 450cd  
535240



## LAMP HOLDER, SLEWABLE

12~



Socket/Bulb:  
GX5,3/MR16 (excl.)  
35W max.

Versions:  
black/2 pce.

Art. No.:  
181080

Recommended bulb:  
35W, 40°, 2700K, 810cd  
535338



## ROPE LAMP MR16

12~

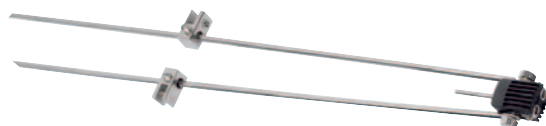

Socket/Bulb:  
GX5,3/MR16 (excl.)  
35W max.

Dimensions:  
L: 60 cm

Versions:  
black

Art. No.:  
139162

Recommended bulb:  
35W, 40°, 2700K, 810cd  
535338



## ACCESSORY for low-voltage rope system



Low-voltage rope,  
25A max., 4 mm<sup>2</sup>  
isolated/1 roll  
Product-L: 100 m  
Weight: 4,6 kg

12~

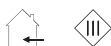

Art. No.:  
139004



Feed-in, 25A max.  
chrome/2 pce.

Art. No.:  
186352



Low-voltage rope,  
25A max., 6 mm<sup>2</sup>  
isolated/1 roll  
Product-L: 100 m  
Weight: 6,4 kg

Art. No.:  
139006



Insulating coupler  
chrome/2 pce.  
Product-L: 6 cm

Art. No.:  
186362



Wall bracket, short  
chrome/2 pce.  
Base-Ø/L: 5/3 cm

Screws (incl.)

Art. No.:  
186302



Wall bracket, middle  
chrome/2 pce.  
Base-Ø/L: 5/10 cm

With clamping device.  
Screws (incl.)

Art. No.:  
186312



Deflector, short  
chrome/2 pce.  
Base-Ø/L: 5/6 cm

Screws (incl.)

Art. No.:  
186332



Deflector, long  
chrome/2 pce.  
Base-Ø/L: 5/16 cm

Screws (incl.)

Art. No.:  
186342



Ceiling deflector  
chrome/2 pce.  
Base-Ø/L: 5/16,2 cm

With deflector roll.  
Screws (incl.)

Art. No.:  
186642



Rope tightener, flexible  
chrome/2 pce.  
Product-L: 9-12,5 cm

Art. No.:  
181532